

**CA139, CA139A, CA239, CA239A
CA339, CA339A, LM339*, LM339A***

Quad Voltage Comparators

For Industrial, Commercial, and Military Applications

Features:

- Operation from single or dual supplies
- Common-mode input-voltage range to ground
- Output voltage compatible with TTL, DTL, ECL, MOS and CMOS
- Differential input-voltage range equal to the supply voltage
- Maximum input-offset voltage (V_{io}):
CA139A, CA239A, CA339A - 2 mV
CA139, CA239, CA339 - 5 mV
- Replacement for industry types 139, 239, 339, 139A, 239A, and 339A

The RCA-CA139, CA239, CA339, CA139A, CA239A, and CA339A types consist of four independent single- or dual-supply voltage comparators on a single monolithic substrate. The common-mode input voltage range includes ground even when operated from a single supply, and the low power supply current drain makes these comparators suitable for battery operation. These types were designed to directly interface with TTL and CMOS.

Applications:

- Square-wave generators
- Time-delay generators
- Pulse generators
- Multivibrators
- High-voltage digital logic gates
- A/D converters
- MOS clock timers

Types CA139A, CA239A, and CA339A have all the features and characteristics of their prototype counter parts CA139, CA239, and CA339 plus an even lower input-offset-voltage characteristic. These devices are supplied in a 14-lead dual-in-line plastic package (E suffix) and in a 14-lead dual-in-line hermetic (frit-seal) ceramic package (F suffix). The CA339 is also available in chip form (H suffix).

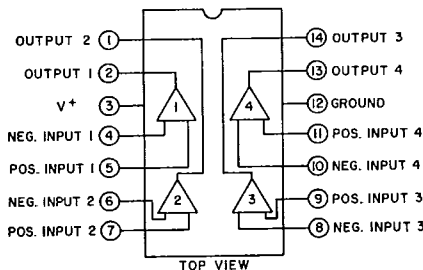

92CS-24149

Fig. 1 - Functional diagram.

*Technical Data on LM Branded types is identical to the corresponding CA Branded types.

Voltage Comparators

CA139, CA139A, CA239, CA239A
CA339, CA339A, LM339, LM339A

MAXIMUM RATINGS, Absolute-Maximum Values at $T_A = 25^\circ\text{C}$:

DC SUPPLY VOLTAGE	36 V or ± 18 V
DC DIFFERENTIAL INPUT VOLTAGE	± 36 V
INPUT VOLTAGE	-0.3 V to +36 V
INPUT CURRENT ($V_I < -0.3$ V)*	50 mA
OUTPUT SHORT CIRCUIT TO GROUND [▲] (Single Supply)	Continuous
DEVICE DISSIPATION:	
Up to $T_A = 55^\circ\text{C}$	750 mW
Above $T_A = 55^\circ\text{C}$	derate linearly at 6.67 mW/ $^\circ\text{C}$
AMBIENT TEMPERATURE RANGE:	
Operating	-55 to +125 $^\circ\text{C}$
Storage	-65 to +150 $^\circ\text{C}$
LEAD TEMPERATURE (DURING SOLDERING):	
At distance $1/16 \pm 1/32$ in. (1.59 ± 0.79 mm)	
from case for 10 seconds max.	+265 $^\circ\text{C}$

* Inputs must not go more negative than -0.3 V.

[▲] Short circuits from the output to V^+ can cause excessive heating and eventual destruction. The maximum output current independent of V^+ is approximately 20 mA.

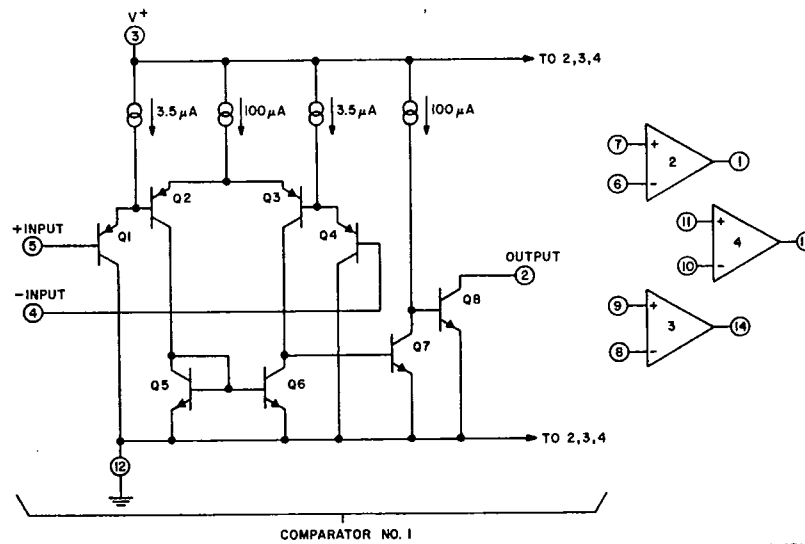

Fig. 2—Schematic diagram.

CA139, CA139A, CA239, CA239A
CA339, CA339A, LM339, LM339A

ELECTRICAL CHARACTERISTICS

CHARACTERISTIC	TEST CONDITIONS		LIMITS						UNITS
	V ⁺ = 5 V		CA139			CA139A			
	Unless otherwise indicated		Min.	Typ.	Max.	Min.	Typ.	Max.	
Input Offset Voltage (V _{IO}) At Output Switch Point V ≅ 1.4 V	V _{REF} = 1.4 V, R _S = 0	25°C	-	2	5	-	1	2	mV
		Note 1	-	-	9	-	-	4	
Differential Input Voltage (V _{ID})	Keep all inputs ≥ 0 V for V ⁻ (if used), Notes 1, 2		-	-	36	-	-	36	V
Saturation Voltage (V _{sat})	V _I ⁻ = 1 V, V _I ⁺ = 0 V, I _{SINK} ≤ 4 mA	25°C	-	250	400	-	250	400	mV
		Note 1	-	-	700	-	-	700	
Common-Mode Input Voltage Range (V _{ICR})	Note 3	25°C	0	-	V ⁺ -1.5	0	-	V ⁺ -1.5	V
		Note 1	0	-	V ⁺ -2	0	-	V ⁺ -2	
Input Offset Current (I _{IO})	I _I ⁺ - I _I ⁻	25°C	-	3	25	-	3	25	nA
		Note 1	-	-	100	-	-	100	
Input Bias Current (I _{IB})	I _I ⁺ or I _I ⁻ with Output in Linear Range	25°C	-	25	100	-	25	100	nA
		Note 1	-	-	300	-	-	300	
Total Supply Current (I ⁺)	R _L = ∞ on all comparators, T _A = 25°C		-	0.8	2	-	0.8	2	mA
Output Leakage Current	V _I ⁺ ≥ 1 V, V _I ⁻ = 0, V _O = 5 V	25°C	-	0.1	-	-	0.1	-	nA
		Note 1	-	-	1	-	-	1	μA
Output Sink Current	V _I ⁻ ≥ 1 V, V _I ⁺ = 0, V _O ≤ +1.5 V, T _A = 25°C		6	16	-	6	16	-	mA
Voltage Gain (A _{OL})	R _L ≥ 15 kΩ, V ⁺ = 15 V, T _A = 25°C		-	200	-	50	200	-	V/mV
Large Signal Response Time	V _I = TTL Logic Swing, V _{REF} = +1.4 V, V _{RL} = 50 V, R _L = 5.1 kΩ, T _A = 25°C		-	300	-	-	300	-	ns
Response Time See Figs. 5 & 6	V _{RL} = 5 V, R _L = 5.1 kΩ, T _A = 25°C		-	1.3	-	-	1.3	-	μs

Note 1: Ambient Temperature (T_A) applicable over operating temperature range as shown below.

CA139 (-55 to +125°C)	CA239 (-25 to +85°C)	CA339 (0 to +70°C)
CA139A	CA239A	CA339A

Note 2: The comparator will provide a proper output state even if the positive swing of the inputs exceeds the power supply voltage level, if the other input remains within the common-mode voltage range. The low input voltage state must not be less than -0.3 V (or 0.3 V below the magnitude of the negative power supply, if used).

Note 3: The upper end of the common-mode voltage range is (V⁺) - 1.5 V, but either or both inputs can go to +30 V without damage.

Voltage Comparators

CA139, CA139A, CA239, CA239A
CA339, CA339A, LM339, LM339A

ELECTRICAL CHARACTERISTICS

CHARACTERISTIC	TEST CONDITIONS		LIMITS						UNITS
	$V^+ = 5\text{ V}$		CA239, CA339			CA239A, CA339A			
	Unless otherwise indicated		Min.	Typ.	Max.	Min.	Typ.	Max.	
Input Offset Voltage (V_{IO}) At Output Switch Point $V \cong 1.4\text{ V}$	$V_{REF} = 1.4\text{ V}, R_S = 0$	25°C	-	2	5	-	1	2	mV
		Note 1	-	-	9	-	-	4	
Differential Input Voltage (V_{ID})	Keep all inputs $\geq 0\text{ V}$ for V^- (if used), Notes 1, 2		-	-	36	-	-	36	V
Saturation Voltage (V_{sat})	$V_I^- = 1\text{ V},$ $V_I^+ = 0\text{ V},$ $I_{SINK} \leq 4\text{ mA}$	25°C	-	250	400	-	250	400	mV
		Note 1	-	-	700	-	-	700	
Common-Mode Input Voltage Range (V_{ICR})	Note 3	25°C	0	-	$V^+ - 1.5$	0	-	$V^+ - 1.5$	V
		Note 1	0	-	$V^+ - 2$	0	-	$V^+ - 2$	
Input Offset Current (I_{IO})	$I_I^+ - I_I^-$	25°C	-	5	50	-	5	50	nA
		Note 1	-	-	150	-	-	150	
Input Bias Current (I_{IB})	I_I^+ or I_I^- with Output in Linear Range	25°C	-	25	250	-	25	250	nA
		Note 1	-	-	400	-	-	400	
Total Supply Current (I^+)	$R_L = \infty$ on all comparators, $T_A = 25^\circ\text{C}$		-	0.8	2	-	0.8	2	mA
Output Leakage Current	$V_I^+ \geq 1\text{ V},$ $V_I^- = 0,$ $V_O = 5\text{ V}$ $V_I^+ \geq 1\text{ V},$ $V_I^- = 0,$ $V_O = 30\text{ V}$	25°C	-	0.1	-	-	0.1	-	nA
		Note 1	-	-	1	-	-	1	μA
Output Sink Current	$V_I^- \geq 1\text{ V},$ $V_I^+ = 0,$ $V_O \leq +1.5\text{ V},$ $T_A = 25^\circ\text{C}$		6	16	-	6	16	-	mA
Voltage Gain (A_{OL})	$R_L \geq 15\text{ k}\Omega, V^+ = 15\text{ V},$ $T_A = 25^\circ\text{C}$		-	200	-	50	200	-	V/mV
Large Signal Response Time	$V_I = \text{TTL Logic Swing}, V_{REF} = +1.4\text{ V}, V_{RL} = 50\text{ V},$ $R_L = 5.1\text{ k}\Omega,$ $T_A = 25^\circ\text{C}$		-	300	-	-	300	-	ns
Response Time See Figs. 5 & 6	$V_{RL} = 5\text{ V},$ $R_L = 5.1\text{ k}\Omega,$ $T_A = 25^\circ\text{C}$		-	1.3	-	-	1.3	-	μs

Note 1: Ambient Temperature (T_A) applicable over operating temperature range as shown below.
 CA139 (-55 to +125°C) CA239 (-25 to +85°C) CA339 (0 to +70°C)
 CA139A (-55 to +125°C) CA239A (-25 to +85°C) CA339A (0 to +70°C)

Note 2: The comparator will provide a proper output state even if the positive swing of the inputs exceeds the power supply voltage level, if the other input remains within the common-mode voltage range. The low input voltage state must not be less than -0.3 V (or 0.3 V below the magnitude of the negative power supply, if used).

Note 3: The upper end of the common-mode voltage range is (V^+) - 1.5 V, but either or both inputs can go to +30 V without damage.

**CA139, CA139A, CA239, CA239A
CA339, CA339A, LM339, LM339A**

TYPICAL CHARACTERISTICS

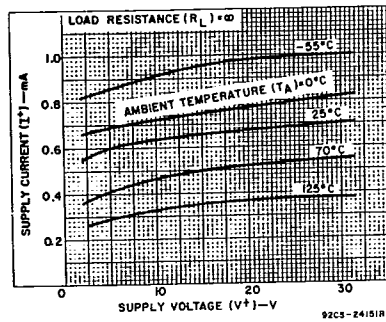

Fig. 3—Supply current vs. supply voltage.

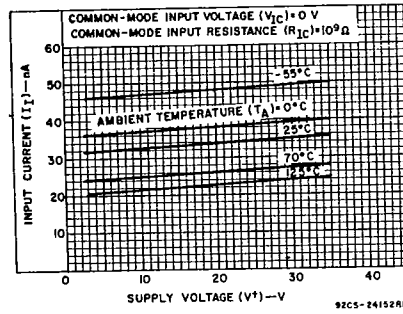

Fig. 4—Input current vs. supply voltage.

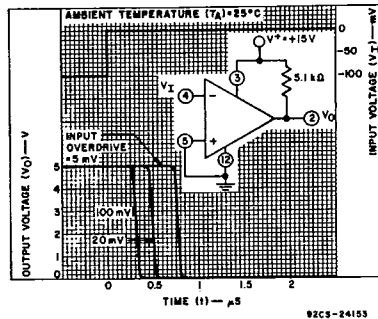

Fig. 5—Response time for various input overdrives—negative transition.

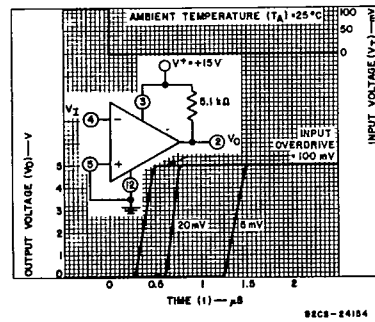

Fig. 6—Response time for various input overdrives—positive transition.

Chip Version (CA339H)

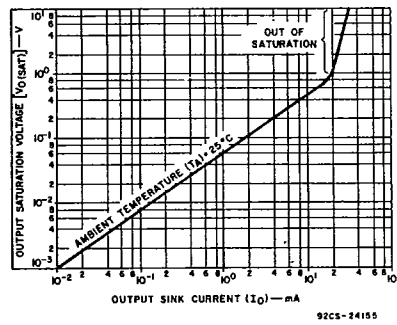
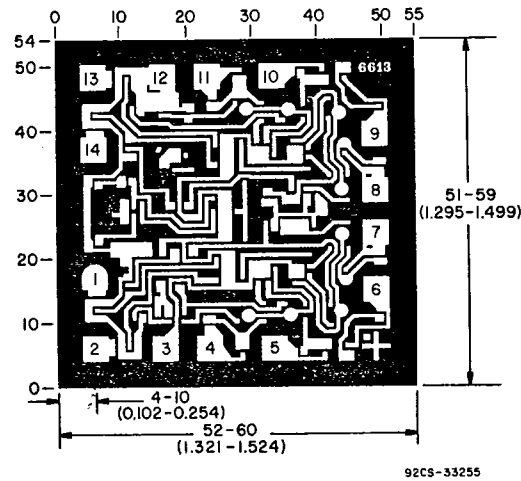

Fig. 7—Output saturation voltage vs. output sink current.



Dimensions in parentheses are in millimeters and are derived from the basic inch dimensions as indicated. Grid graduations are in mils (10^{-3} inch).