

IRFD120PbF

HEXFET® Power MOSFET

- Dynamic dv/dt Rating
- Repetitive Avalanche Rated
- For Automatic Insertion
- End Stackable
- 175°C Operating Temperature
- Fast Switching
- Ease of Paralleling
- Lead-Free

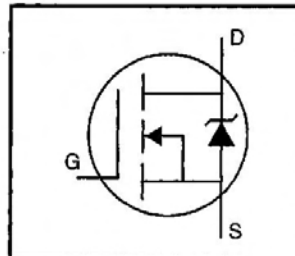

$V_{DSS} = 100V$
 $R_{DS(on)} = 0.27\Omega$
 $I_D = 1.3A$

Description

Third Generation HEXFETs from International Rectifier provide the designer with the best combination of fast switching, ruggedized device design, low on-resistance and cost-effectiveness.

The 4-pin DIP package is a low cost machine-insertable case style which can be stacked in multiple combinations on standard 0.1 inch pin centers. The dual drain serves as a thermal link to the mounting surface for power dissipation levels up to 1 watt.

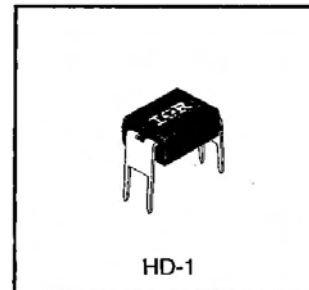

Absolute Maximum Ratings

| | Parameter | Max. | Units |
|---------------------------|--|-----------------------|-------|
| $I_D @ T_C = 25^\circ C$ | Continuous Drain Current, $V_{GS} @ 10 V$ | 1.3 | A |
| $I_D @ T_C = 100^\circ C$ | Continuous Drain Current, $V_{GS} @ 10 V$ | 0.94 | |
| I_{DM} | Pulsed Drain Current ① | 10 | |
| $P_D @ T_C = 25^\circ C$ | Power Dissipation | 1.3 | W |
| | Linear Derating Factor | 0.0083 | W/°C |
| V_{GS} | Gate-to-Source Voltage | ± 20 | V |
| E_{AS} | Single Pulse Avalanche Energy ② | 100 | mJ |
| I_{AR} | Avalanche Current ① | 1.3 | A |
| E_{AR} | Repetitive Avalanche Energy ① | 0.13 | mJ |
| dv/dt | Peak Diode Recovery dv/dt ③ | 5.5 | V/ns |
| T_J | Operating Junction and Storage Temperature Range | -55 to +175 | °C |
| T_{STG} | | | |
| | Soldering Temperature, for 10 seconds | 300 (1.6mm from case) | |

Thermal Resistance

| | Parameter | Min. | Typ. | Max. | Units |
|-----------------|---------------------|------|------|------|-------|
| $R_{\theta JA}$ | Junction-to-Ambient | — | — | 120 | °C/W |

Electrical Characteristics @ T_J = 25°C (unless otherwise specified)

| | Parameter | Min. | Typ. | Max. | Units | Test Conditions |
|--|--------------------------------------|------|------|------|-------|---|
| V _{(BR)DSS} | Drain-to-Source Breakdown Voltage | 100 | — | — | V | V _{GS} =0V, I _D =250μA |
| ΔV _{(BR)DSS} /ΔT _J | Breakdown Voltage Temp. Coefficient | — | 0.13 | — | V/°C | Reference to 25°C, I _D =1mA |
| R _{DS(on)} | Static Drain-to-Source On-Resistance | — | — | 0.27 | Ω | V _{GS} =10V, I _D =0.78A ④ |
| V _{GS(th)} | Gate Threshold Voltage | 2.0 | — | 4.0 | V | V _{DS} =V _{GS} , I _D =250μA |
| g _{fs} | Forward Transconductance | 0.80 | — | — | S | V _{DS} =50V, I _D =0.78A ④ |
| I _{DSS} | Drain-to-Source Leakage Current | — | — | 25 | μA | V _{DS} =100V, V _{GS} =0V |
| | | — | — | 250 | | V _{DS} =80V, V _{GS} =0V, T _J =150°C |
| I _{GSS} | Gate-to-Source Forward Leakage | — | — | 100 | nA | V _{GS} =20V |
| | Gate-to-Source Reverse Leakage | — | — | -100 | | V _{GS} =-20V |
| Q _g | Total Gate Charge | — | — | 16 | nC | I _D =9.2A |
| Q _{gs} | Gate-to-Source Charge | — | — | 4.4 | | V _{DS} =80V |
| Q _{gd} | Gate-to-Drain ("Miller") Charge | — | — | 7.7 | | V _{GS} =10V See Fig. 6 and 13 ④ |
| t _{d(on)} | Turn-On Delay Time | — | 6.8 | — | ns | V _{DD} =50V |
| t _r | Rise Time | — | 27 | — | | I _D =9.2A |
| t _{d(off)} | Turn-Off Delay Time | — | 18 | — | | R _G =18Ω |
| t _f | Fall Time | — | 17 | — | | R _D =5.2Ω See Figure 10 ④ |
| L _D | Internal Drain Inductance | — | 4.0 | — | nH | Between lead, 6 mm (0.25in.) from package and center of die contact |
| L _S | Internal Source Inductance | — | 6.0 | — | | |
| C _{iss} | Input Capacitance | — | 360 | — | pF | V _{GS} =0V |
| C _{oss} | Output Capacitance | — | 150 | — | | V _{DS} =25V |
| C _{rss} | Reverse Transfer Capacitance | — | 34 | — | | f=1.0MHz See Figure 5 |

Source-Drain Ratings and Characteristics

| | Parameter | Min. | Typ. | Max. | Units | Test Conditions |
|-----------------|--|--|------|------|-------|---|
| I _S | Continuous Source Current (Body Diode) | — | — | 1.3 | A | MOSFET symbol showing the integral reverse p-n junction diode. |
| I _{SM} | Pulsed Source Current (Body Diode) ① | — | — | 10 | | |
| V _{SD} | Diode Forward Voltage | — | — | 2.5 | V | T _J =25°C, I _S =1.3A, V _{GS} =0V ④ |
| t _{rr} | Reverse Recovery Time | — | 130 | 260 | ns | T _J =25°C, I _F =9.2A |
| Q _{rr} | Reverse Recovery Charge | — | 0.65 | 1.3 | μC | di/dt=100A/μs ④ |
| t _{on} | Forward Turn-On Time | Intrinsic turn-on time is negligible (turn-on is dominated by L _S +L _D) | | | | |

Notes:

① Repetitive rating; pulse width limited by max. junction temperature (See Figure 11)

③ I_{SD}≤9.2A, di/dt≤110A/μs, V_{DD}≤V_{(BR)DSS}, T_J≤175°C

② V_{DD}=25V, starting T_J=25°C, L=22mH, R_G=25Ω, I_{AS}=2.6A (See Figure 12)

④ Pulse width ≤ 300 μs; duty cycle ≤2%.

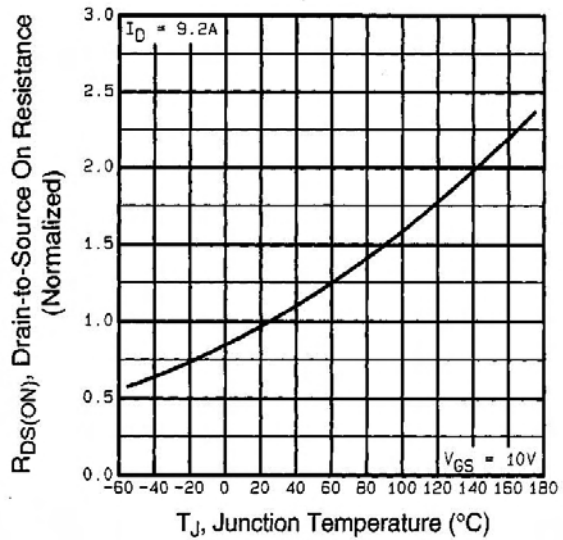
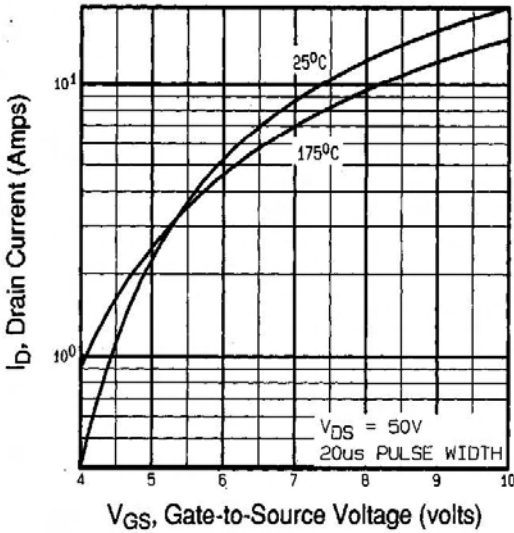
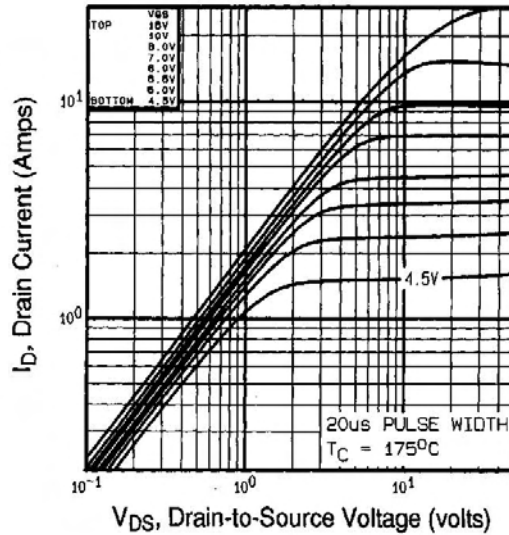
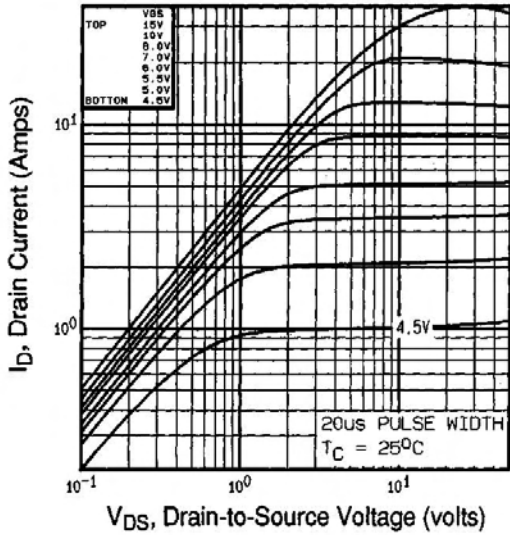

IRFD120PbF

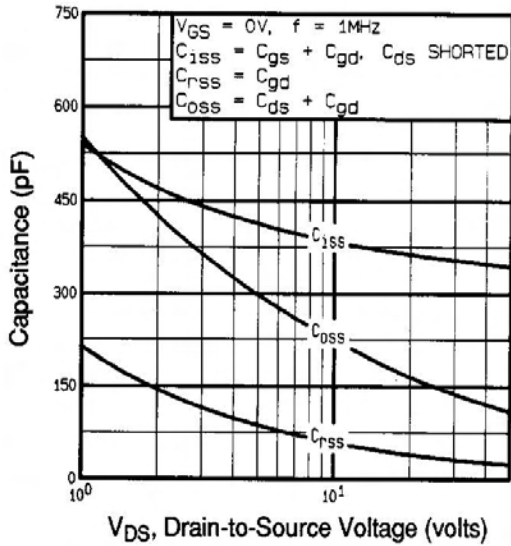

Fig 5. Typical Capacitance Vs. Drain-to-Source Voltage

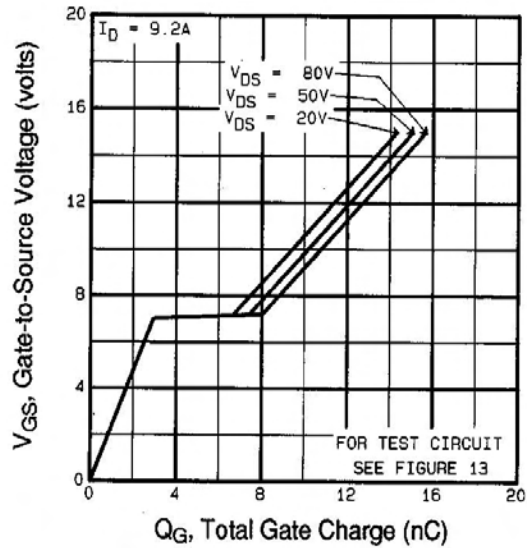

Fig 6. Typical Gate Charge Vs. Gate-to-Source Voltage

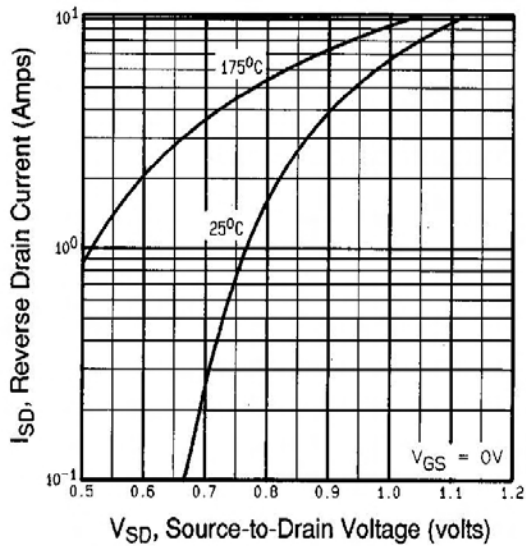

Fig 7. Typical Source-Drain Diode Forward Voltage

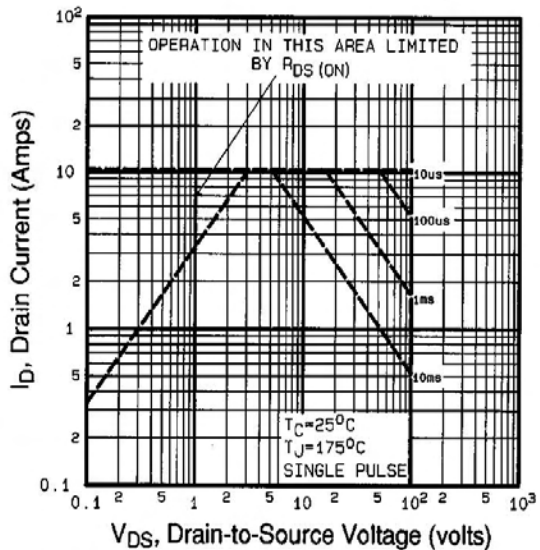

Fig 8. Maximum Safe Operating Area

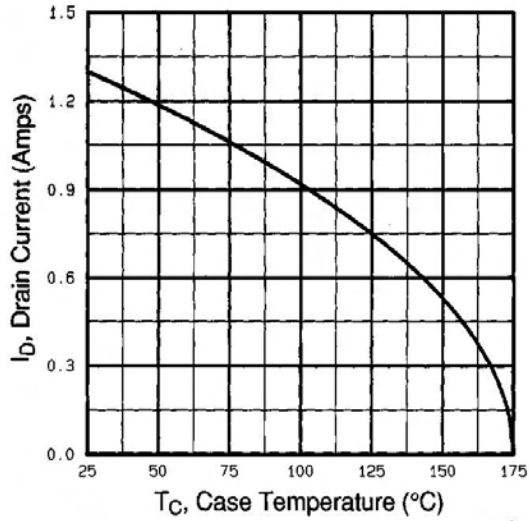

Fig 9. Maximum Drain Current Vs. Case Temperature

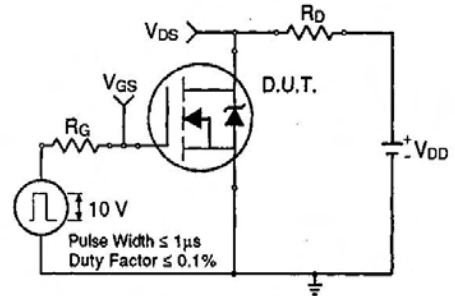

Fig 10a. Switching Time Test Circuit

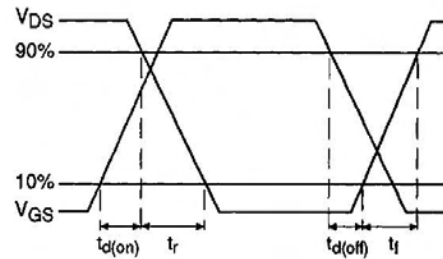

Fig 10b. Switching Time Waveforms

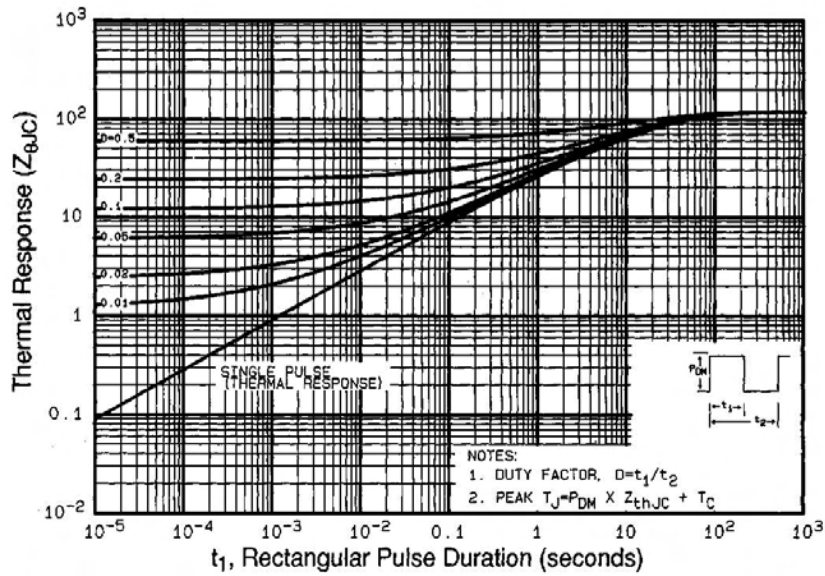

Fig 11. Maximum Effective Transient Thermal Impedance, Junction-to-Case

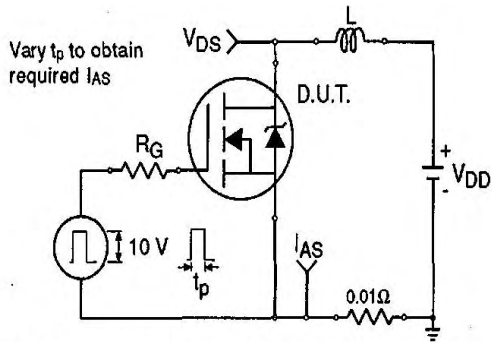

Fig 12a. Unclamped Inductive Test Circuit

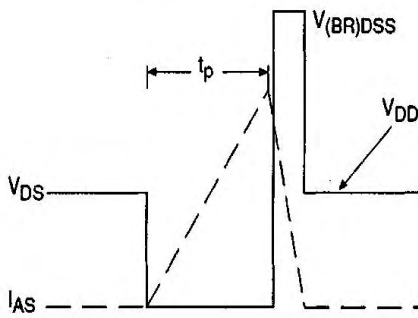

Fig 12b. Unclamped Inductive Waveforms

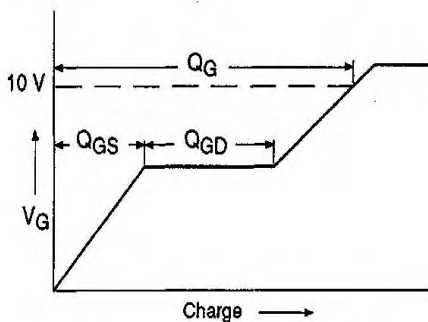

Fig 13a. Basic Gate Charge Waveform

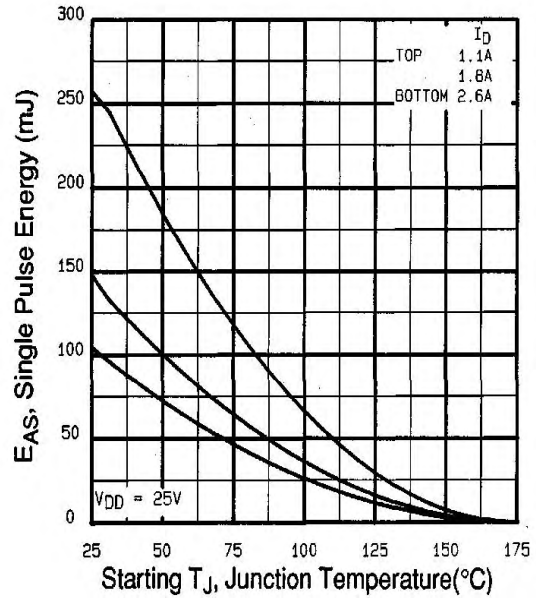

Fig 12c. Maximum Avalanche Energy Vs. Drain Current

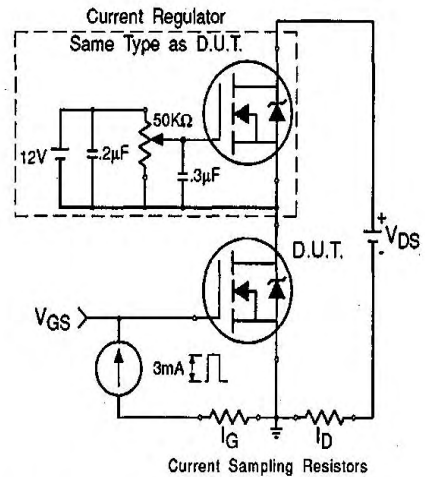
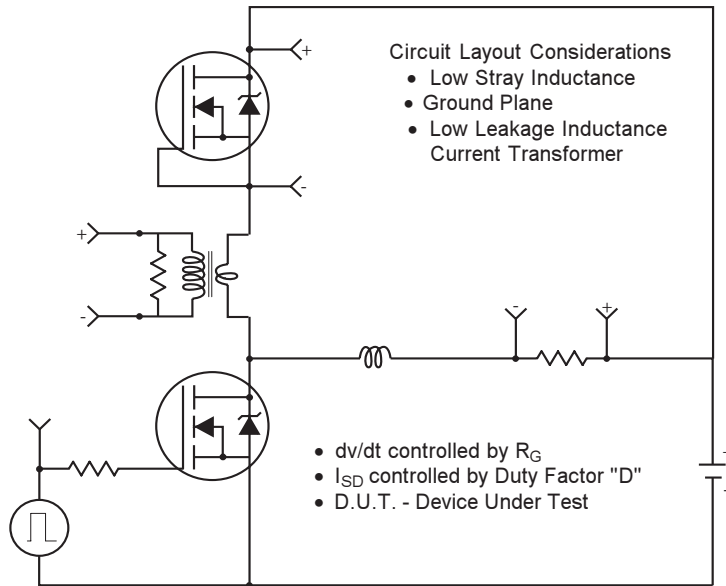

Fig 13b. Gate Charge Test Circuit

Peak Diode Recovery dv/dt Test Circuit



* Reverse Polarity for P-Channel

** Use P-Channel Driver for P-Channel Measurements

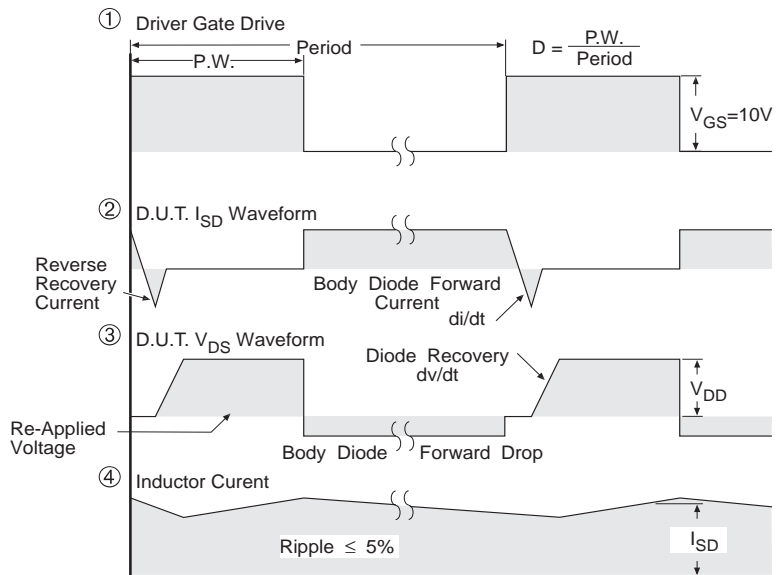

*** $V_{GS} = 5.0V$ for Logic Level and 3V Drive Devices

Fig -14 For N Channel HEXFETS

IRFD120PbF

Hexdip Package Outline

Dimensions are shown in millimeters (inches)



NOTES:

- ① APPLIES TO SPREAD OF LEADS PRIOR TO INSTALLATION
- ② APPLIES TO INSTALLED LEAD CENTERS
- 3 CONTROLLING DIMENSION: INCH.
- 4 DIMENSIONS ARE SHOWN MILLIMETERS (INCHES).
- 5 CASE STYLE HD-1 (SIMILAR TO JEDEC OUTLINE MO-001AN)
- 6 DIMENSIONS SHOWN ARE BEFORE SOLDER DIP
SOLDER DIP MAX. + 0.16 (0.006)

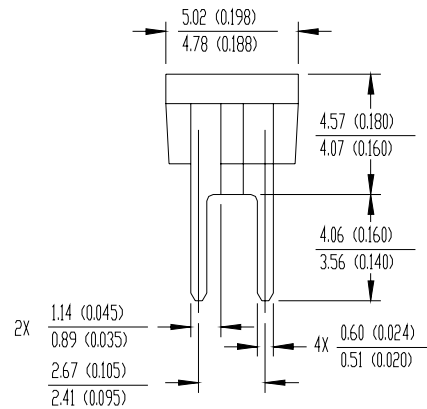
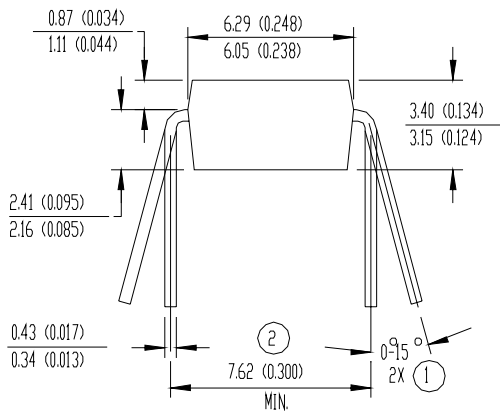

Hexdip Part Marking Information

EXAMPLE: THIS IS AN IRFD120

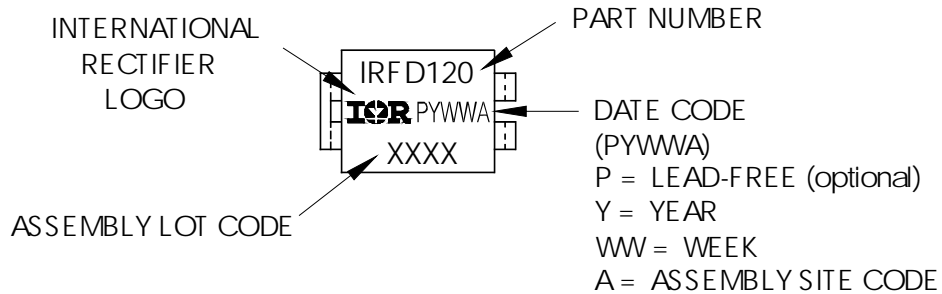

Data and specifications subject to change without notice.



IR WORLD HEADQUARTERS: 233 Kansas St., El Segundo, California 90245, USA Tel: (310) 252-7105
TAC Fax: (310) 252-7903

Visit us at www.irf.com for sales contact information. 10/04

www.irf.com