

Cree® XLamp® ML-E LEDs



PRODUCT DESCRIPTION

The Cree XLamp ML-E LED brings lighting-class reliability and performance to 1/2-watt LEDs. The XLamp ML-E expands Cree’s lighting-class leadership to LED bulbs and linear and distributed lighting applications. With XLamp lighting-class reliability, a wide viewing angle, uniform light output, and industry-leading chromaticity binning in a 3.5-mm X 3.5-mm package, the XLamp ML-E LED continues Cree’s history of segment-focused product innovation in LEDs for lighting applications.

The XLamp ML-E LED brings high performance and a smooth look to a wide range of lighting applications, including linear lighting, LED light bulbs, fluorescent retrofits and retail-display lighting.

FEATURES

- Available in white (2,600 K to 8,300 K CCT), 80-, 85- and 90-CRI minimum
- Available in blue, green and red
- Available in parallel and series
- ANSI-compatible sub-bins
- Maximum drive current: 500 mA for parallel white, 167 mA for series white, 350 mA for color
- 120° viewing angle for white and red, 125° viewing angle for blue and green
- Uniform chromaticity profile
- Electrically neutral thermal path
- RoHS and REACH compliant
- Unlimited floor life at $\leq 30\text{ }^{\circ}\text{C}/85\%\text{ RH}$

TABLE OF CONTENTS

Flux Characteristics.....	2
Characteristics	5
Relative Spectral Power Distribution .	6
Relative Flux vs. Junction Temperature	7
Electrical Characteristics	8
Relative Flux vs. Current	9
Thermal Design.....	11
Typical Spatial Distribution.....	14
Reflow Soldering Characteristics	16
Notes.....	17
Mechanical Dimensions.....	18
Tape and Reel	19
Packaging.....	20

FLUX CHARACTERISTICS - ML-E PARALLEL WHITE ($T_j = 25\text{ }^\circ\text{C}$)

The following table provides several base order codes for XLamp ML-E LEDs. It is important to note that the base order codes listed here are a subset of the total available order codes for the product family. For more order codes, as well as a complete description of the order-code nomenclature, please consult the XLamp ML-E LED Binning and Labeling document.

Color	CCT Range		Base Order Codes Minimum Luminous Flux (lm) @ 150 mA		Calculated Minimum Luminous Flux (lm)*		Order Code
	Min.	Max.	Group	Flux (lm)	350 mA	500 mA	
Cool White	5,000 K	8,300 K	M3	45.7	92.6	117.4	MLEAWT-A1-0000-000351
			N2	51.7	104.8	132.9	MLEAWT-A1-0000-000451
80-CRI Cool White	6,000 K	7,000 K	M3	45.7	92.6	117.4	MLEAWT-H1-0000-0003E1
	4,750 K	5,250 K	M3	45.7	92.6	117.4	MLEAWT-H1-0000-0003E3
Warm White	3,700 K	4,300 K	M2	39.8	80.7	102.3	MLEAWT-A1-0000-0002E5
			M3	45.7	92.6	117.4	MLEAWT-A1-0000-0003E5
	2,800 K	3,200 K	K3	35.2	71.4	90.5	MLEAWT-A1-0000-0001E7
			M2	39.8	80.7	102.3	MLEAWT-A1-0000-0002E7
80-CRI Warm White	3,700 K	4,300 K	M2	39.8	80.7	102.3	MLEAWT-H1-0000-0002E5
	2,800 K	3,200 K	K3	35.2	71.4	90.5	MLEAWT-H1-0000-0001E7
85-CRI Warm White	2,800 K	3,200 K	K3	35.2	71.4	90.5	MLEAWT-P1-0000-0001E7
90-CRI Warm White	2,800 K	3,200 K	K2	30.6	62	78.6	MLEAWT-P1-0000-0000E7

Notes:

- Cree maintains a tolerance of $\pm 7\%$ on flux and power measurements, ± 0.005 on chromaticity (CCx, CCy) measurements and ± 2 on CRI measurements.
- Typical CRI for Cool White (4,300 K – 8,300 K CCT) is 75.
- Typical CRI for Warm White (2,600 K – 4,300 K CCT) is 80.
- Minimum CRI for 80-CRI White is 80.
- Minimum CRI for 85-CRI White is 85.
- Minimum CRI for 90-CRI White is 90
- * Calculated flux values are for reference only.

FLUX CHARACTERISTICS - ML-E SERIES WHITE ($T_j = 25\text{ }^\circ\text{C}$)

The following table provides several base order codes for XLamp ML-E LEDs. It is important to note that the base order codes listed here are a subset of the total available order codes for the product family. For more order codes, as well as a complete description of the order-code nomenclature, please consult the XLamp ML-E LED Binning and Labeling document.

Color	CCT Range		Base Order Codes Minimum Luminous Flux (lm) @ 50 mA		Calculated Minimum Luminous Flux (lm)*		Order Code
	Min.	Max.	Group	Flux (lm)	117 mA	166 mA	
Cool White	5,000 K	8,300 K	M3	45.7	92.6	117.4	MLESWT-A1-0000-000351
			N2	51.7	104.8	132.9	MLESWT-A1-0000-000451
80-CRI Cool White	6,000 K	7,000 K	M3	45.7	92.6	117.4	MLESWT-H1-0000-0003E1
	4,750 K	5,250 K	M3	45.7	92.6	117.4	MLESWT-H1-0000-0003E3
Warm White	3,700 K	4,300 K	M2	39.8	80.7	102.3	MLESWT-A1-0000-0002E5
			M3	45.7	92.6	117.4	MLESWT-A1-0000-0003E5
	2,800 K	3,200 K	K3	35.2	71.4	90.5	MLESWT-A1-0000-0001E7
			M2	39.8	80.7	102.3	MLESWT-A1-0000-0002E7
80-CRI Warm White	3,700 K	4,300 K	M2	39.8	80.7	102.3	MLESWT-H1-0000-0002E5
	2,800 K	3,200 K	K3	35.2	71.4	90.5	MLESWT-H1-0000-0001E7
85-CRI Warm White	2,800 K	3,200 K	K3	35.2	71.4	90.5	MLESWT-P1-0000-0001E7
90-CRI Warm White	2,800 K	3,200 K	K2	30.6	62	78.6	MLESWT-P1-0000-0000E7

Notes:

- Cree maintains a tolerance of $\pm 7\%$ on flux and power measurements, ± 0.005 on chromaticity (CCx, CCy) measurements and ± 2 on CRI measurements.
- Typical CRI for Cool White (4,300 K – 8,300 K CCT) is 75.
- Typical CRI for Warm White (2,600 K – 4,300 K CCT) is 80.
- Minimum CRI for 80-CRI White is 80.
- Minimum CRI for 85-CRI White is 85.
- Minimum CRI for 90-CRI White is 90.
- * Calculated flux values are for reference only.

FLUX CHARACTERISTICS (T_J = 25 °C) - COLOR

The following table provides several base order codes for XLamp ML-E LEDs. It is important to note that the base order codes listed here are a subset of the total available order codes for the product family. For more order codes, as well as a complete description of the order-code nomenclature, please consult the XLamp ML Family Binning and Labeling document.

Color	Dominant Wavelength Range				Base Order Codes Minimum Luminous Flux (lm) @ 150 mA		Order Code
	Min.		Max.		Group	Flux (lm)	
	Group	DWL (nm)	Group	DWL (nm)			
Blue	B3	465	B6	485	F0	10.7	MLEBLU-A1-0000-000T01
					G0	13.9	MLEBLU-A1-0000-000U01

Color	Dominant Wavelength Range				Base Order Codes Minimum Luminous Flux (lm) @ 150 mA		Order Code
	Min.		Max.		Group	Flux (lm)	
	Group	DWL (nm)	Group	DWL (nm)			
Green	G2	520	G4	535	J3	26.8	MLEGRN-A1-0000-000X01
					K2	30.6	MLEGRN-A1-0000-000001
					K3	35.2	MLEGRN-A1-0000-000101

Color	Dominant Wavelength Range				Base Order Codes Minimum Luminous Flux (lm) @ 150 mA		Order Code
	Min.		Max.		Group	Flux (lm)	
	Group	DWL (nm)	Group	DWL (nm)			
Red	R2	620	R3	630	H0	18.1	MLERED-A1-0000-000V01
					J0	23.5	MLERED-A1-0000-000W01

Note: Cree maintains a tolerance of ±7% on flux and power measurements.

CHARACTERISTICS (T_j = 25 °C)

Characteristics	Unit	Minimum	Typical	Maximum
Thermal resistance, junction to solder point - white	°C/W		11	
Thermal resistance, junction to solder point - blue	°C/W		11	
Thermal resistance, junction to solder point - green, red	°C/W		15	
Viewing angle (FWHM) - white	degrees		120	
Viewing angle (FWHM) - blue, green	degrees		125	
Viewing angle (FWHM) - red	degrees		120	
Temperature coefficient of voltage - parallel - white	mV/°C		-3.3	
Temperature coefficient of voltage - series - white	mV/°C		-10	
Temperature coefficient of voltage - blue	mV/°C		-1.8	
Temperature coefficient of voltage - green	mV/°C		-3.3	
Temperature coefficient of voltage - red	mV/°C		-4	
ESD classification (HBM per Mil-Std-883D)			Class 2	
DC forward current - parallel - white	mA			500
DC forward current - series - white	mA			167
DC forward current - blue, green, red	mA			350
Reverse voltage	V			-5
Forward voltage (@ 150 mA) - parallel - white	V		3.2	
Forward voltage (@ 50 mA) - series - white	V		9.6	
Forward voltage (@ 150 mA) - blue	V		3.2	
Forward voltage (@ 150 mA) - green	V		3.45	
Forward voltage (@ 150 mA) - red	V		2.2	
LED junction temperature	°C			150

RELATIVE SPECTRAL POWER DISTRIBUTION - WHITE

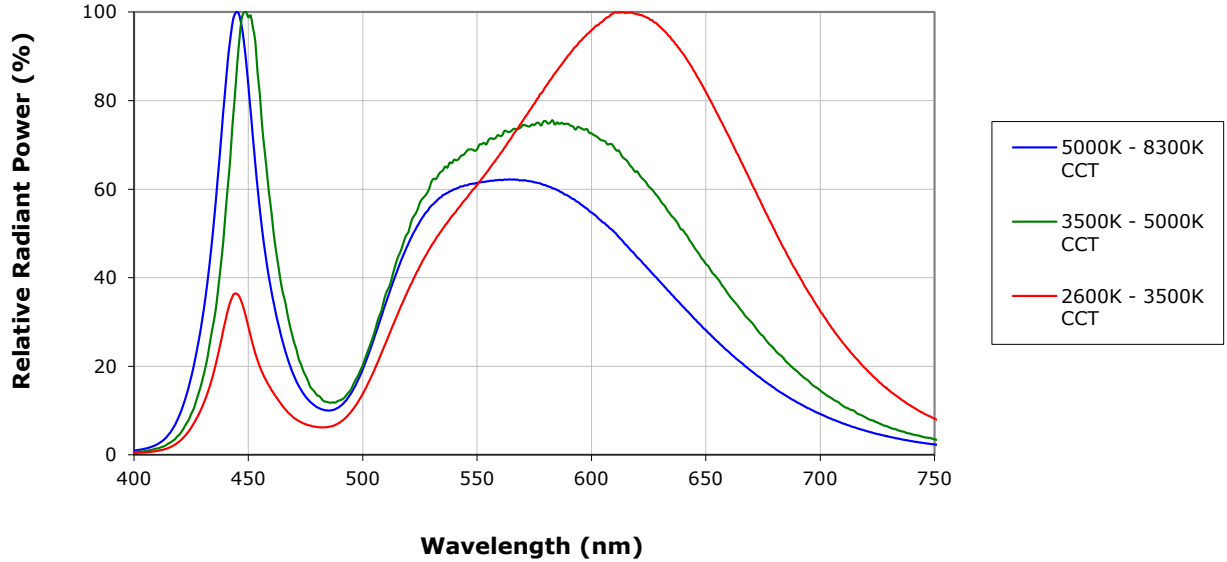

RELATIVE SPECTRAL POWER DISTRIBUTION - COLOR

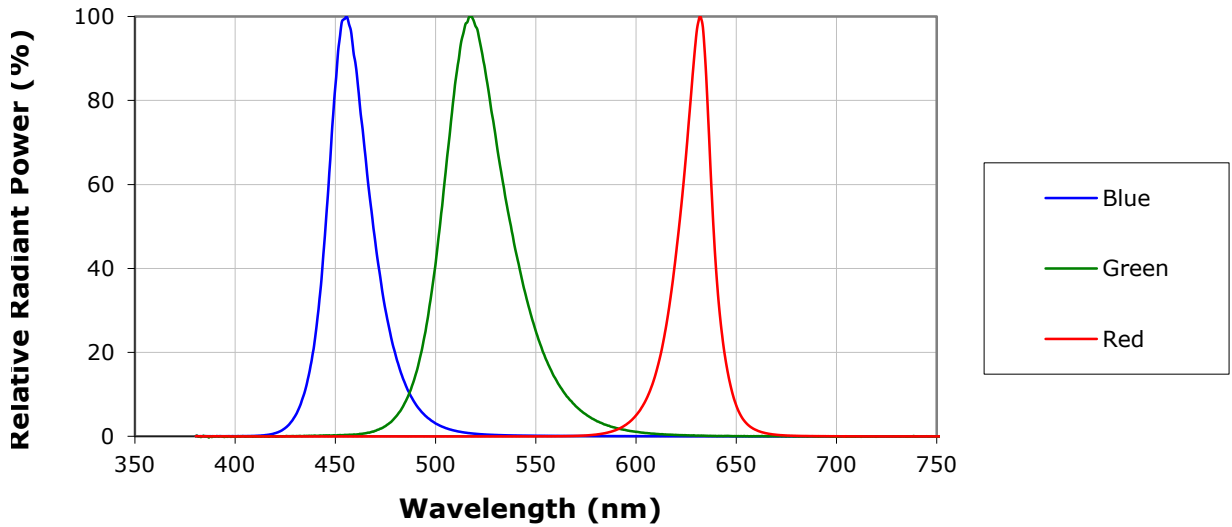

RELATIVE FLUX VS. JUNCTION TEMPERATURE ($I_F = 150$ mA, ML-E PARALLEL $I_F = 50$ mA, ML-E SERIES)

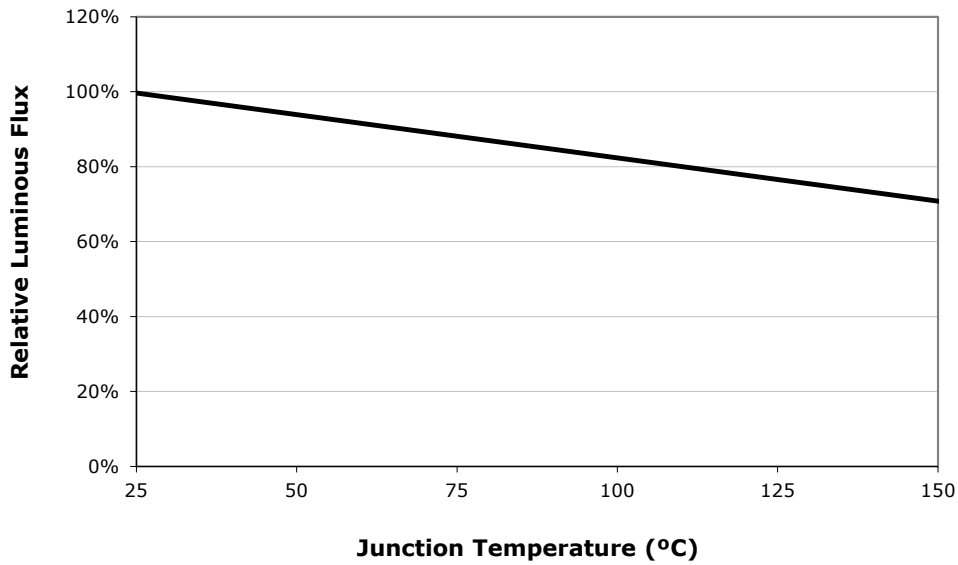

RELATIVE FLUX VS. JUNCTION TEMPERATURE ($I_F = 150$ mA) - COLOR

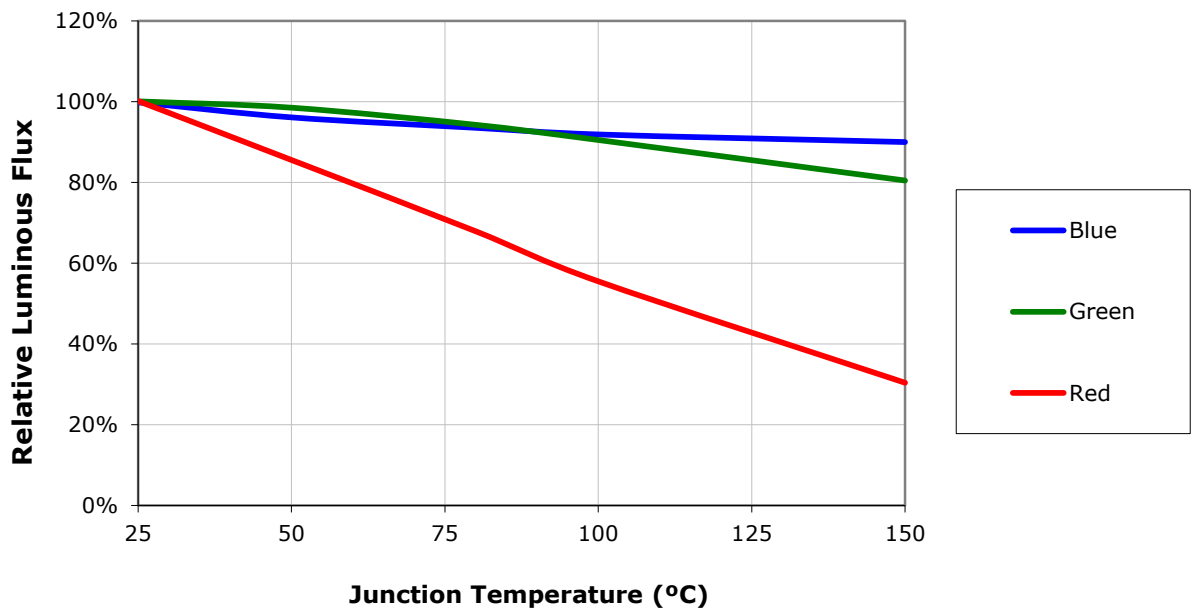

ELECTRICAL CHARACTERISTICS - ML-E PARALLEL ($T_j = 25\text{ }^\circ\text{C}$) - WHITE

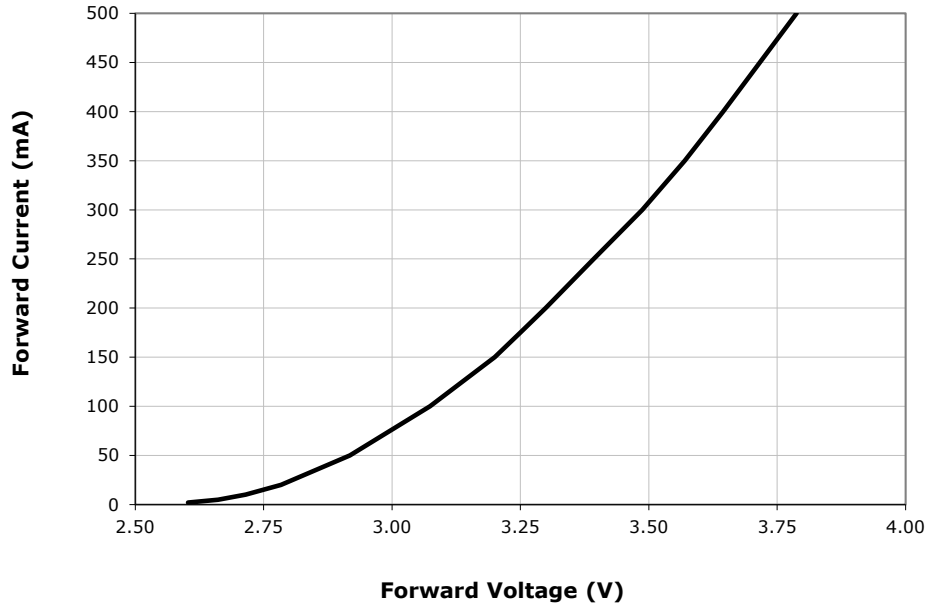

ELECTRICAL CHARACTERISTICS - ML-E SERIES ($T_j = 25\text{ }^\circ\text{C}$) - WHITE

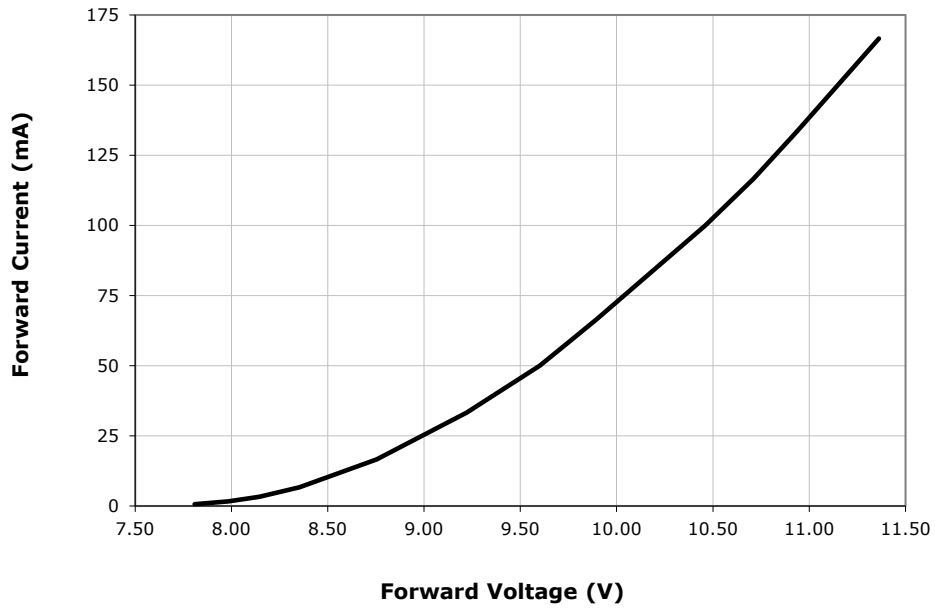

ELECTRICAL CHARACTERISTICS ($T_j = 25\text{ }^\circ\text{C}$) - COLOR

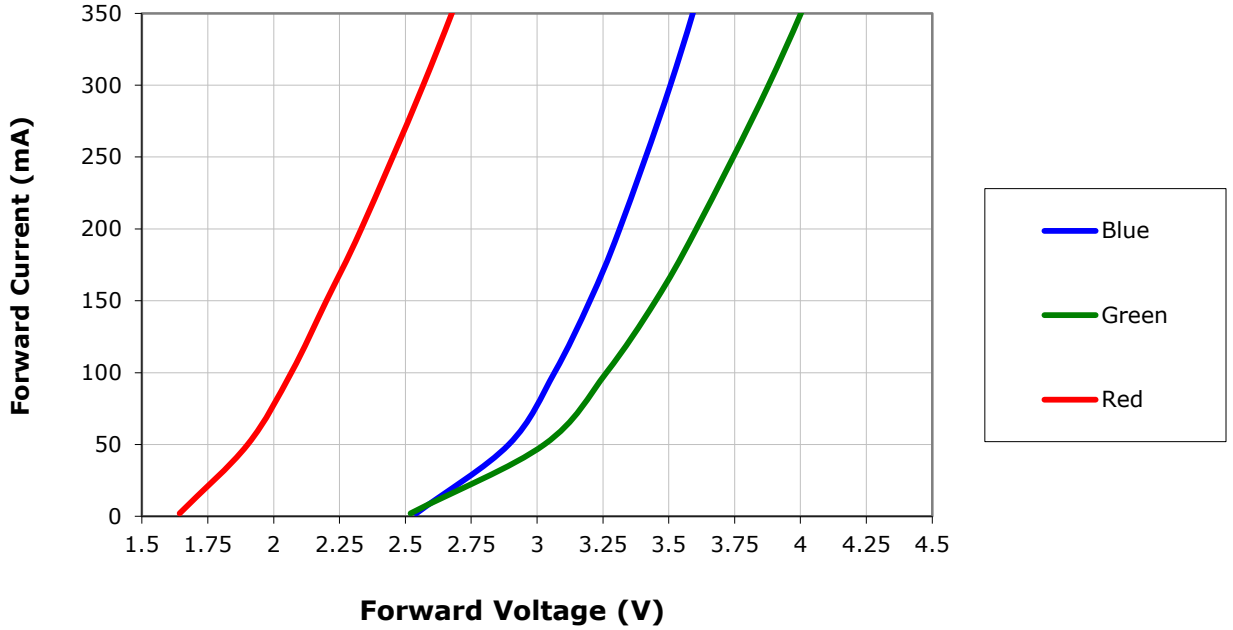

RELATIVE FLUX VS. CURRENT - ML-E PARALLEL ($T_j = 25\text{ }^\circ\text{C}$) - WHITE

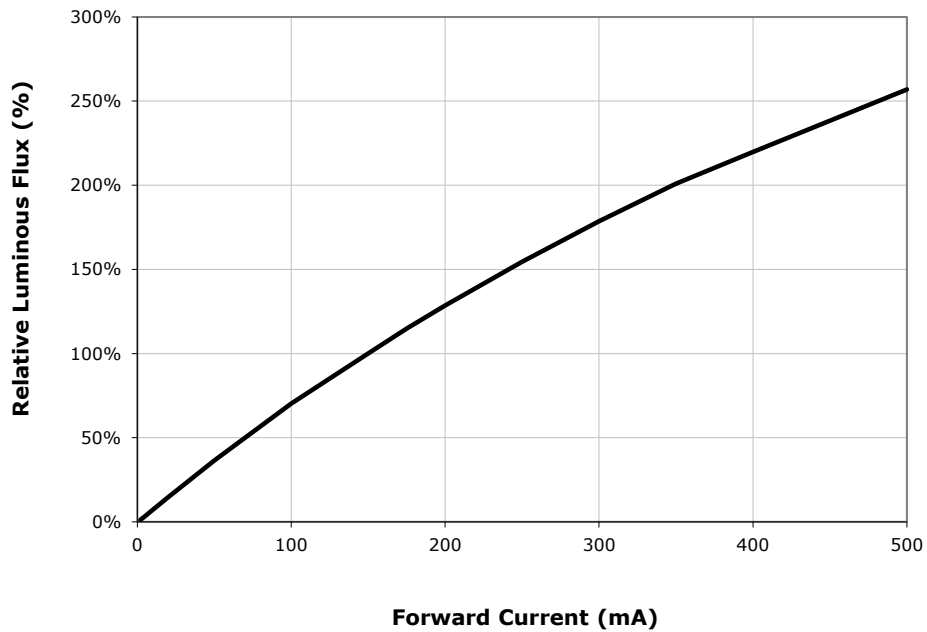

RELATIVE FLUX VS. CURRENT - ML-E SERIES ($T_j = 25\text{ }^\circ\text{C}$) - WHITE

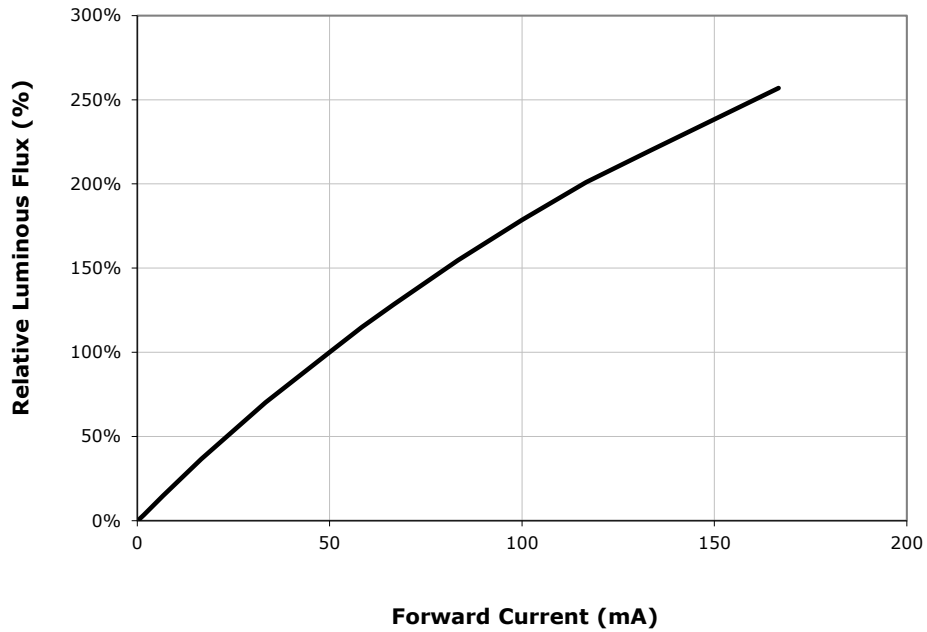

RELATIVE FLUX VS. CURRENT ($T_j = 25\text{ }^\circ\text{C}$) - COLOR

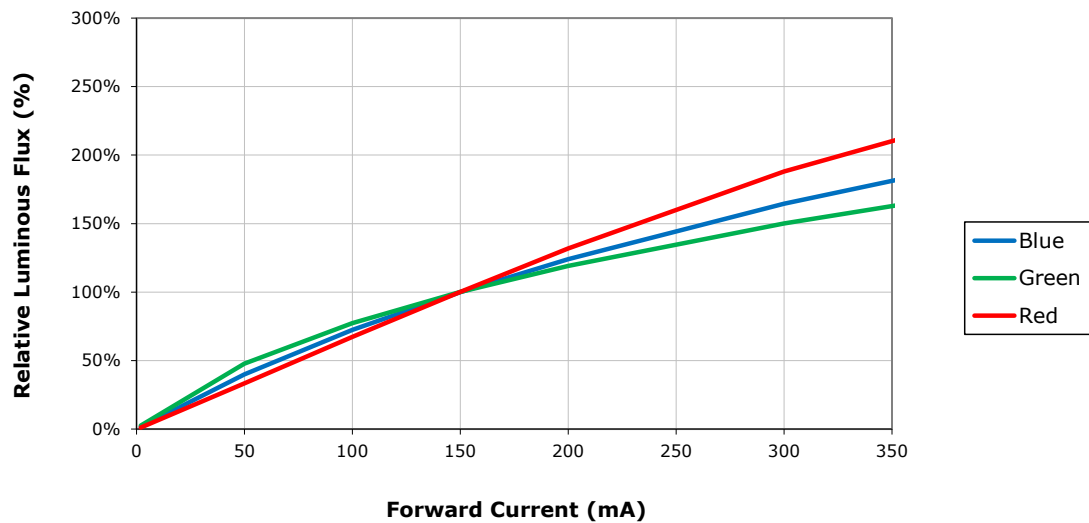

THERMAL DESIGN - ML-E PARALLEL WHITE

The maximum forward current is determined by the thermal resistance between the LED junction and ambient. It is crucial for the end product to be designed in a manner that minimizes the thermal resistance from the solder point to ambient in order to optimize lamp life and optical characteristics.

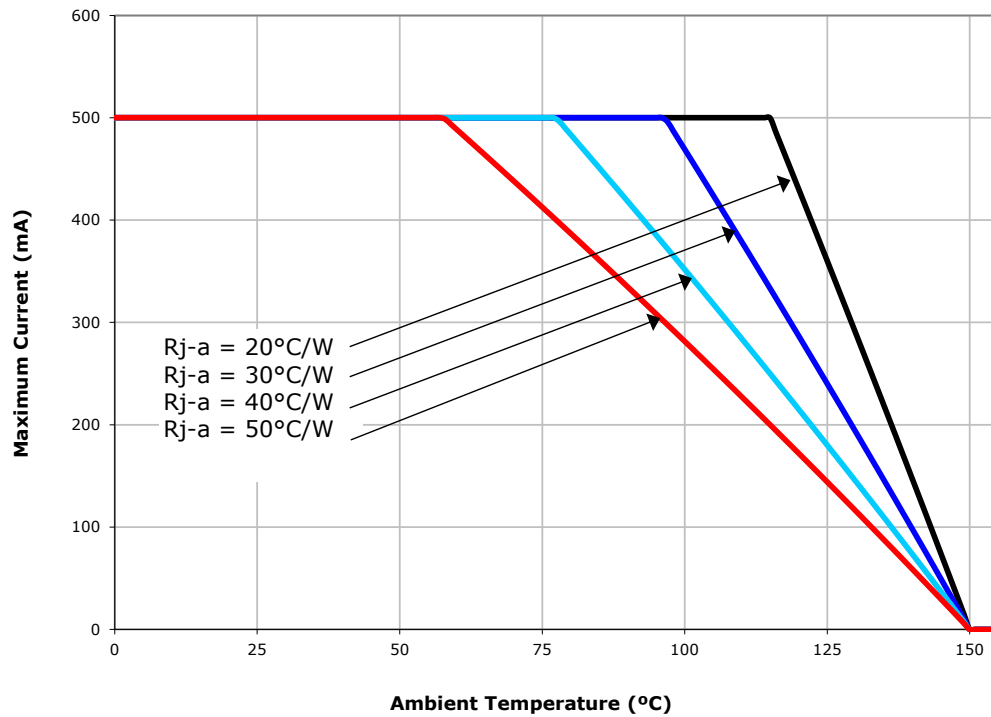

THERMAL DESIGN - ML-E SERIES WHITE

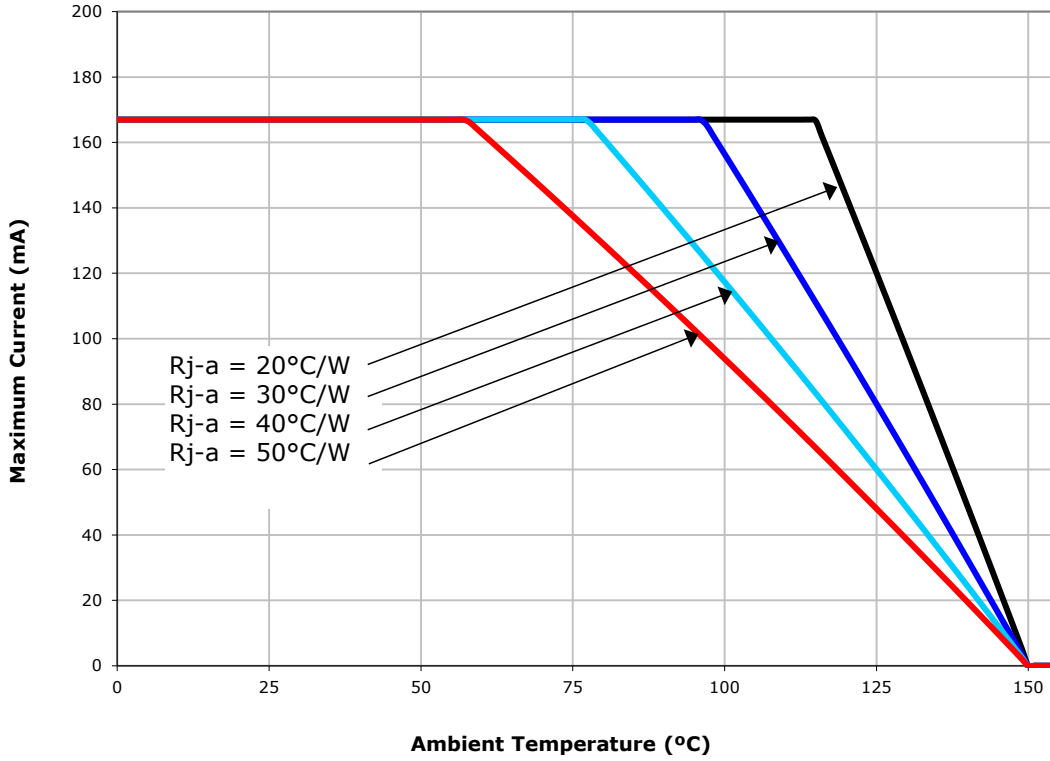

THERMAL DESIGN - BLUE

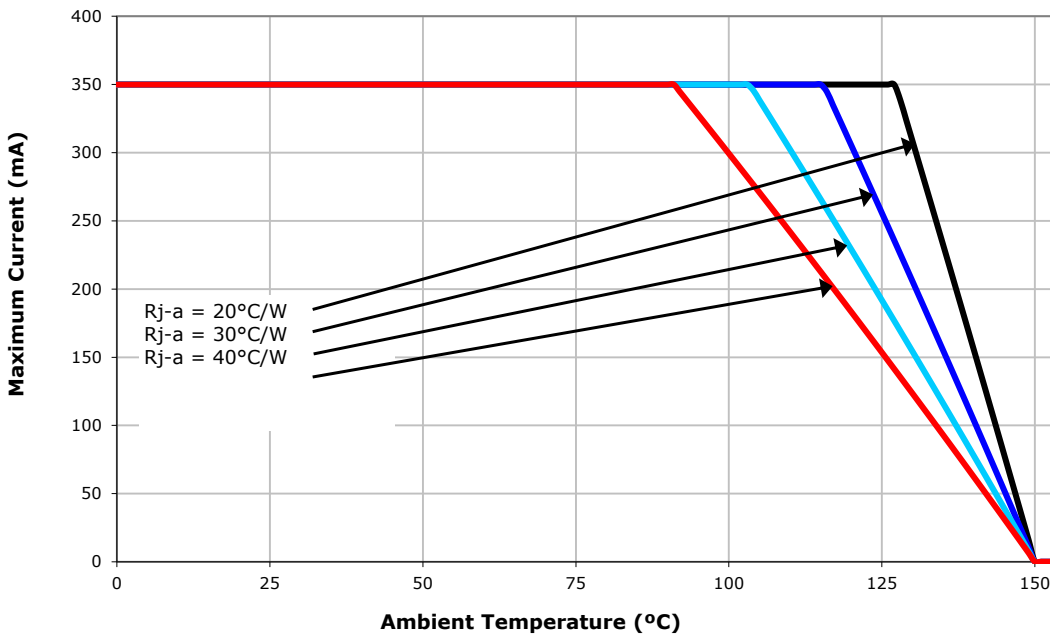

THERMAL DESIGN - GREEN

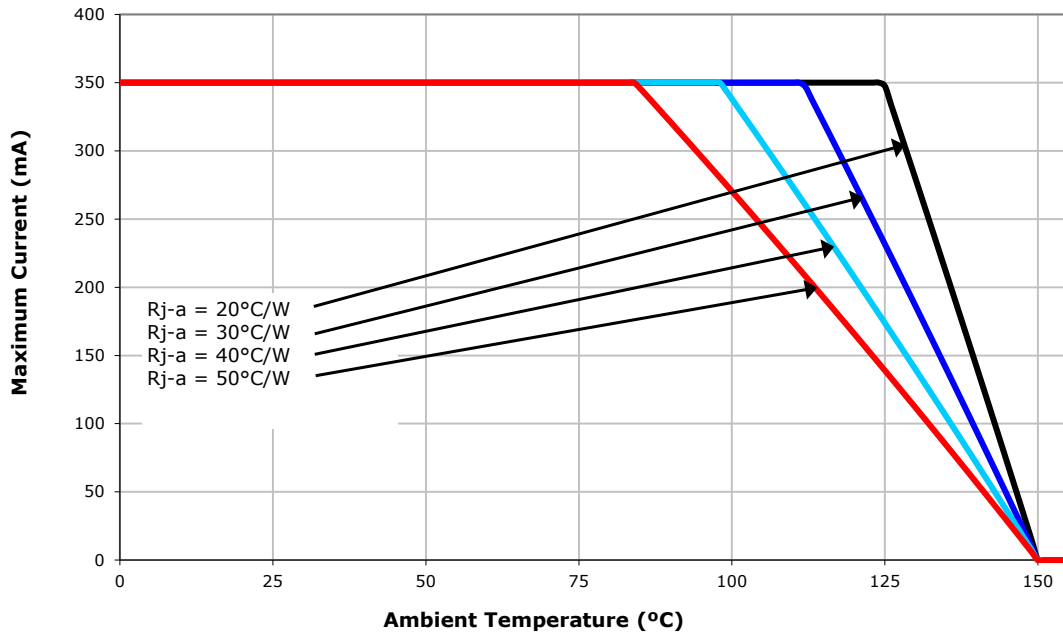

THERMAL DESIGN - RED

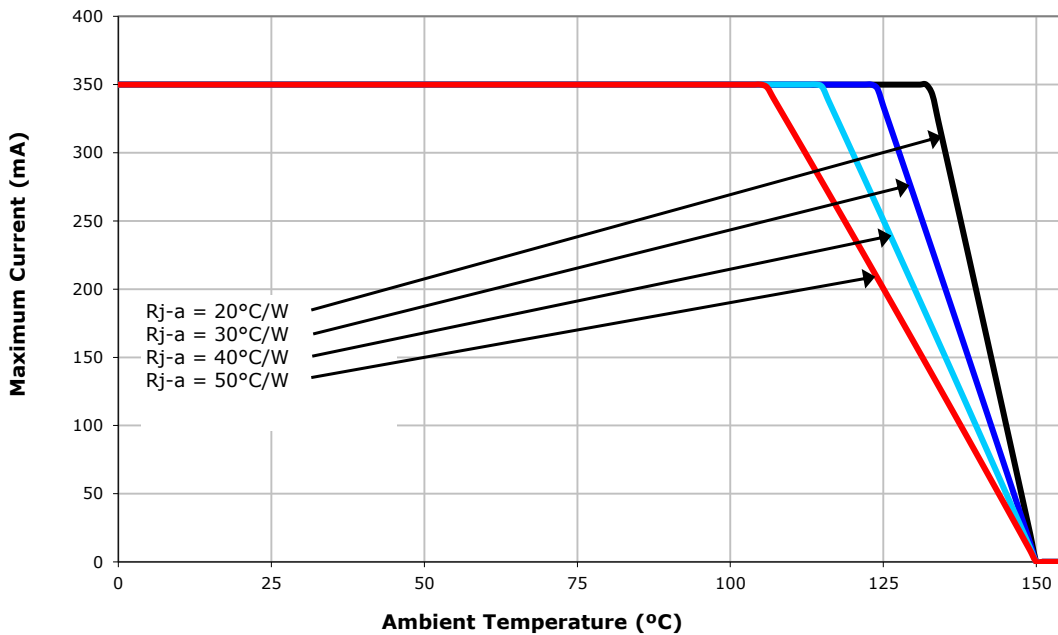

TYPICAL SPATIAL DISTRIBUTION - WHITE

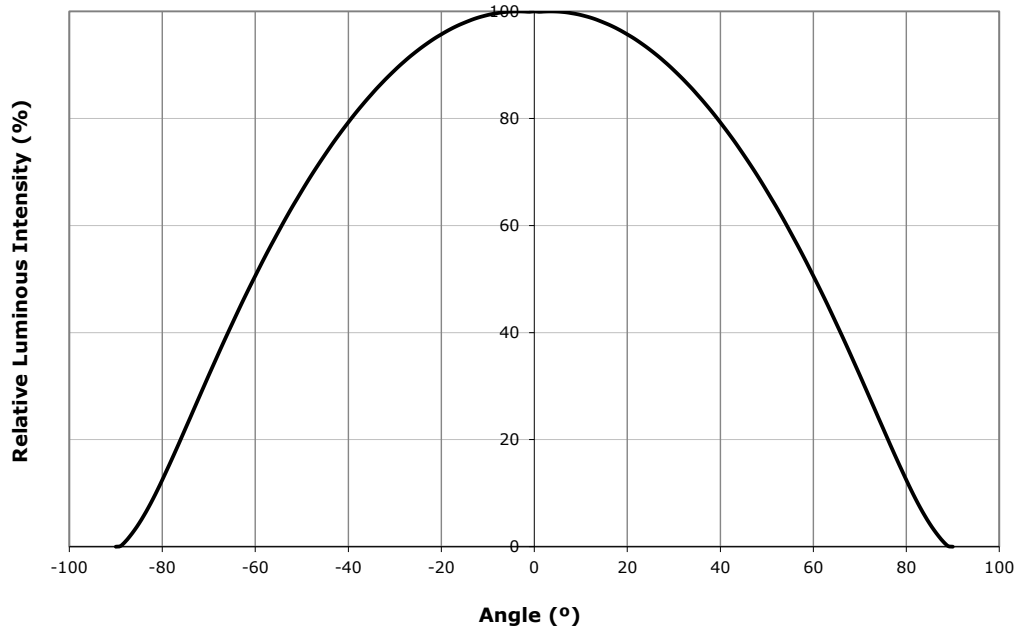

TYPICAL SPATIAL DISTRIBUTION - BLUE

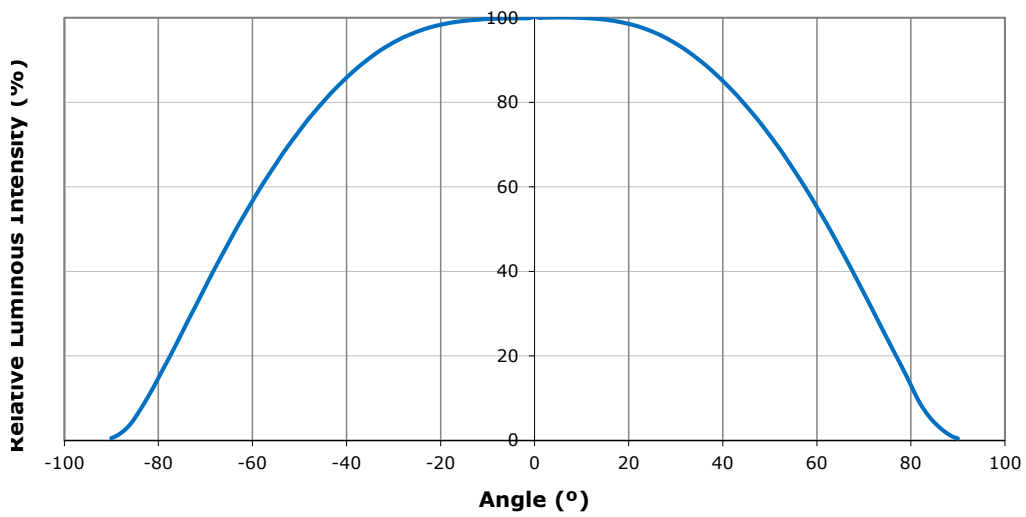

TYPICAL SPATIAL DISTRIBUTION - GREEN

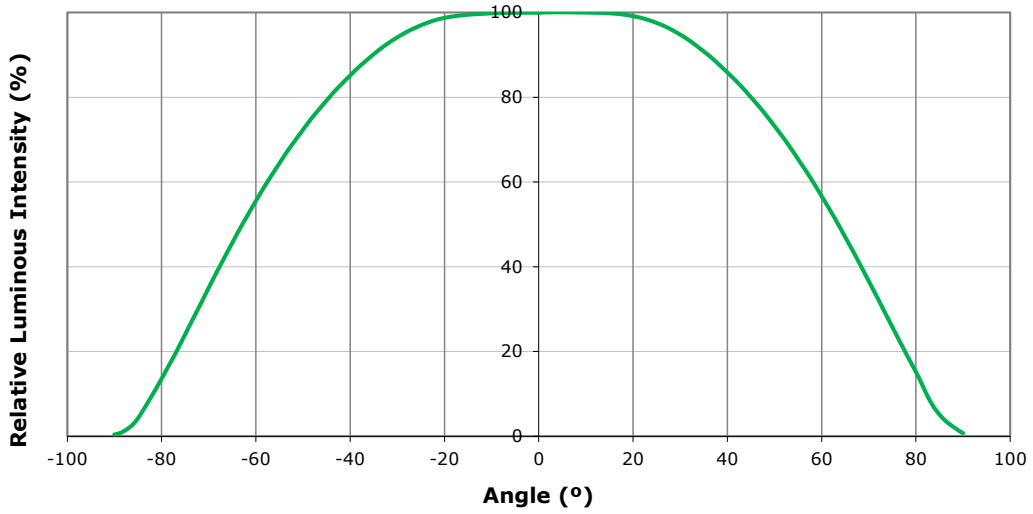

TYPICAL SPATIAL DISTRIBUTION - RED

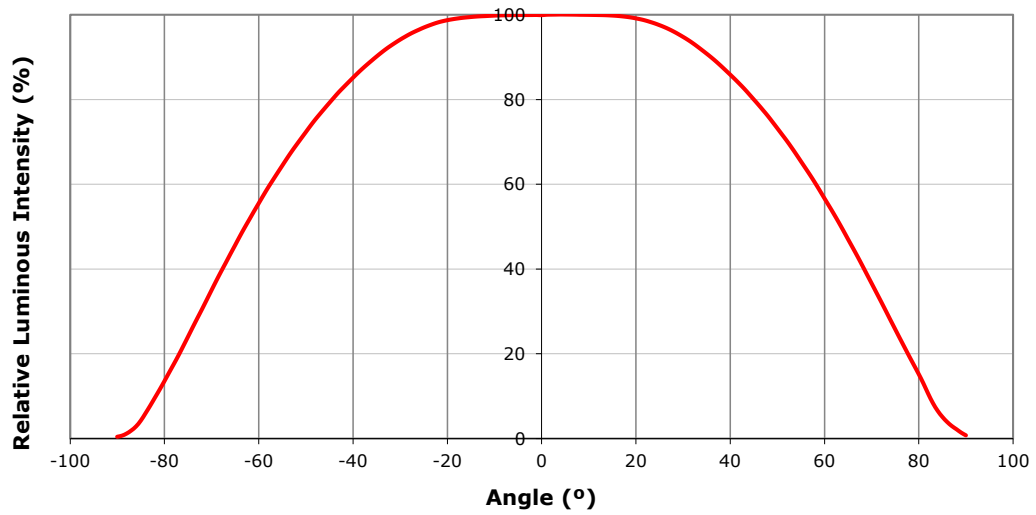

REFLOW SOLDERING CHARACTERISTICS

In testing, Cree has found XLamp ML-E LEDs to be compatible with JEDEC J-STD-020C, using the parameters listed below. As a general guideline, Cree recommends that users follow the recommended soldering profile provided by the manufacturer of the solder paste used.

Note that this general guideline may not apply to all PCB designs and configurations of reflow soldering equipment.

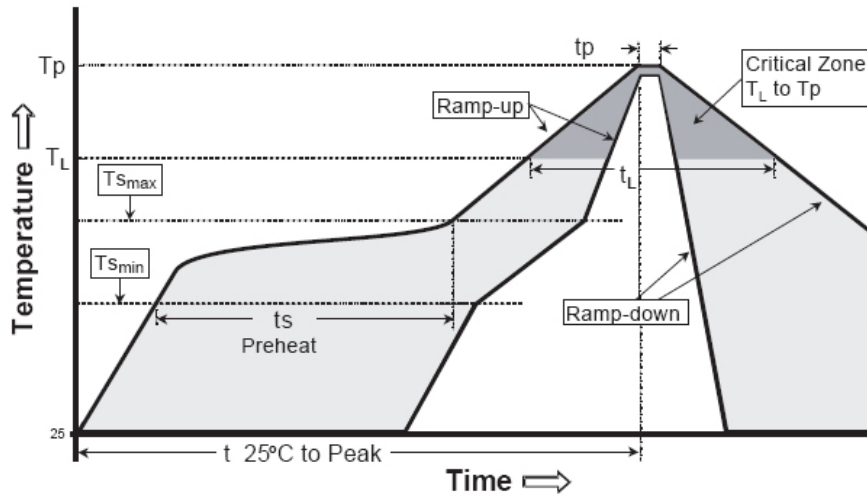

Profile Feature	Lead-Based Solder	Lead-Free Solder
Average Ramp-Up Rate ($T_{s_{max}}$ to T_p)	3 °C/second max.	3 °C/second max.
Preheat: Temperature Min ($T_{s_{min}}$)	100 °C	150 °C
Preheat: Temperature Max ($T_{s_{max}}$)	150 °C	200 °C
Preheat: Time ($t_{s_{min}}$ to $t_{s_{max}}$)	60-120 seconds	60-180 seconds
Time Maintained Above: Temperature (T_L)	183 °C	217 °C
Time Maintained Above: Time (t_L)	60-150 seconds	60-150 seconds
Peak/Classification Temperature (T_p)	215 °C	260 °C
Time Within 5 °C of Actual Peak Temperature (t_p)	10-30 seconds	20-40 seconds
Ramp-Down Rate	6 °C/second max.	6 °C/second max.
Time 25 °C to Peak Temperature	6 minutes max.	8 minutes max.

Note: All temperatures refer to topside of the package, measured on the package body surface.

Note: While the high reflow temperatures (above) have been approved, Cree’s best practice guideline for reflow is to use as low a temperature as possible during the reflow soldering process for these LEDs.

NOTES

Lumen Maintenance Projections

Cree now uses standardized IES LM-80-08 and TM-21-11 methods for collecting long-term data and extrapolating LED lumen maintenance. For information on the specific LM-80 data sets available for this LED, refer to the public LM-80 results document at www.cree.com/products/pdf/LM-80_Results.pdf.

Cree currently recommends a maximum drive current of 175 mA for XLamp ML-E parallel white and 58 mA for XLamp ML-E series white LEDs in designs seeking the ENERGY STAR* 35,000-hour lifetime rating ($\geq 94.1\%$ luminous flux @ 6000 hours) or 25,000-hour lifetime rating ($\geq 91.8\%$ luminous flux @ 6000 hours).

Please read the XLamp Long-Term Lumen Maintenance application note for more details on Cree's lumen maintenance testing and forecasting. Please read the XLamp Thermal Management application note for details on how thermal design, ambient temperature, and drive current affect the LED junction temperature.

* These lifetime ratings are based on the current ENERGY STAR Product Specification for Luminaires (Light Fixtures) V1.0 (February 16, 2011) and ENERGY STAR Program Requirements for Integral LED Lamps V1.4 (May 13, 2011) lumen maintenance criteria.

Moisture Sensitivity

In testing, Cree has found XLamp ML-E LEDs to have unlimited floor life in conditions $\leq 30\text{ }^{\circ}\text{C}/85\%$ relative humidity (RH). Moisture testing included a 168-hour soak at $85\text{ }^{\circ}\text{C}/85\%$ RH followed by 3 reflow cycles, with visual and electrical inspections at each stage.

Cree recommends keeping XLamp LEDs in their sealed moisture-barrier packaging until immediately prior to use. Cree also recommends returning any unused LEDs to the resealable moisture-barrier bag and closing the bag immediately after use.

RoHS Compliance

The levels of environmentally sensitive, persistent biologically toxic (PBT), persistent organic pollutants (POP), or otherwise restricted materials in this product are below the maximum concentration values (also referred to as the threshold limits) permitted for such substances, or are used in an exempted application, in accordance with EU Directive 2002/95/EC on the restriction of the use of certain hazardous substances in electrical and electronic equipment (RoHS), as amended through April 21, 2006.

Vision Advisory Claim

WARNING: Do not look at an exposed lamp in operation. Eye injury can result. See LED Eye Safety at www.cree.com/products/pdf/XLamp_EyeSafety.pdf.

MECHANICAL DIMENSIONS (T_A = 25 °C)

All measurements are ±.13 mm unless otherwise indicated.

Top View

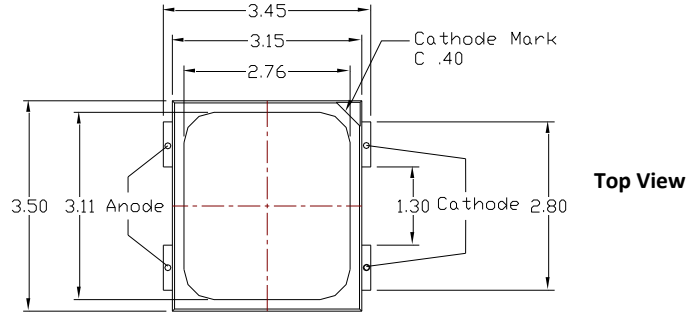
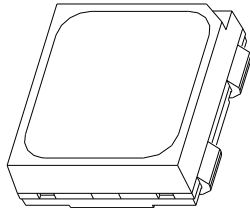

Bottom View

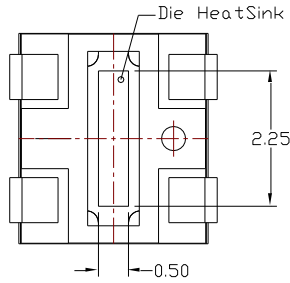

Side View

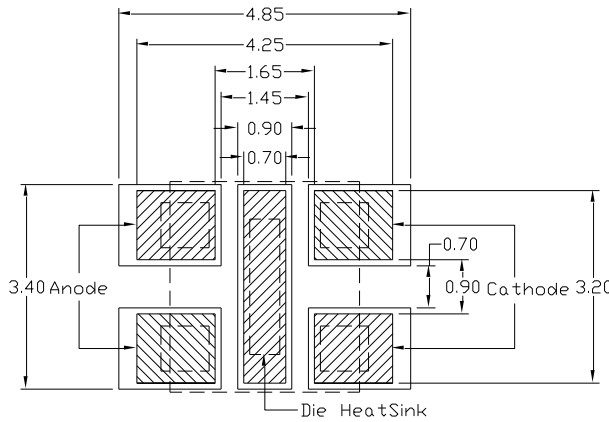
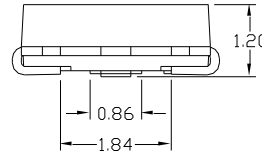

Recommended PCB Solder Pad

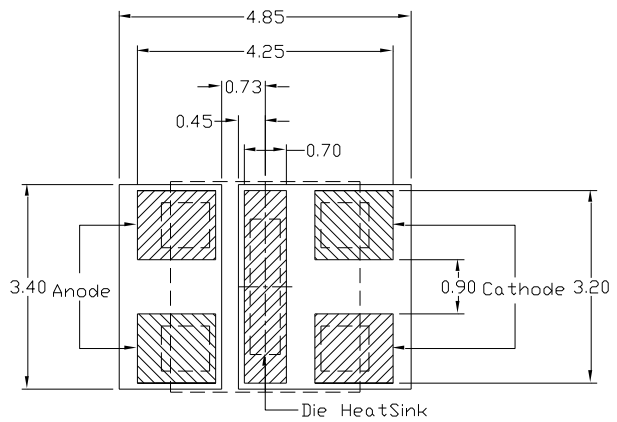

Alternative Solder Pad

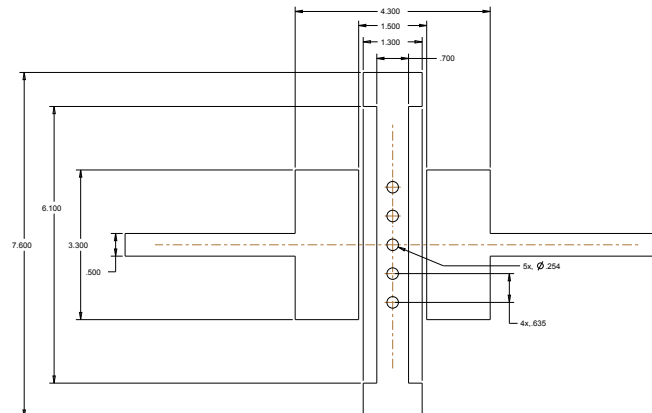

Recommended FR4 Solder Pad w/Thermal Vias

TAPE AND REEL

All Cree carrier tapes conform to EIA-481D, Automated Component Handling Systems Standard.

All dimensions in mm.

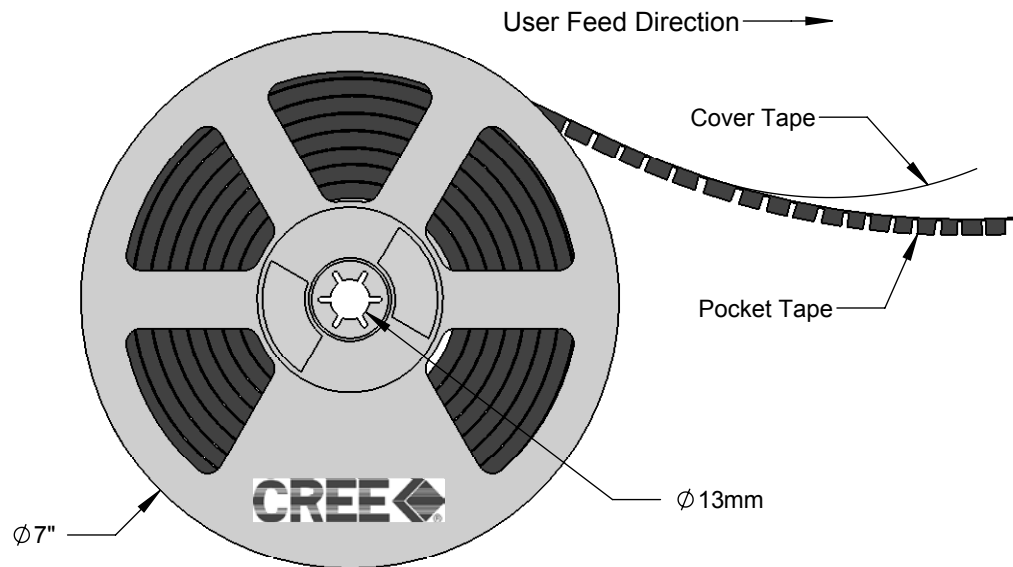
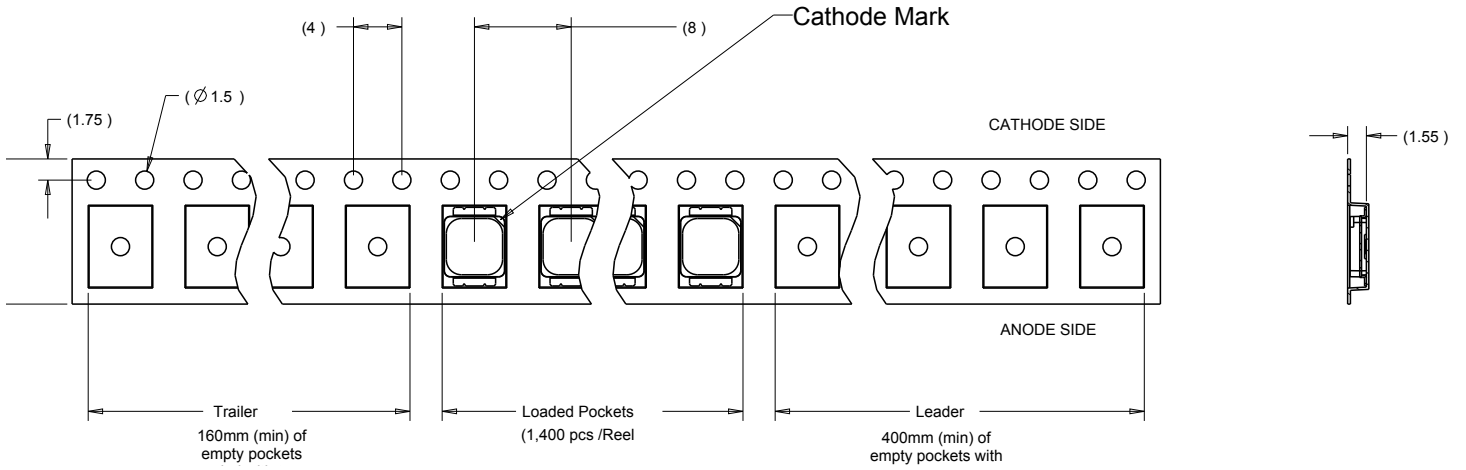

PACKAGING

