

LT1013, LT1013A, LT1013D DUAL PRECISION OPERATIONAL AMPLIFIERS

SLOS018H – MAY 1988 – REVISED NOVEMBER 2004

- **Single-Supply Operation**
 - Input Voltage Range Extends to Ground
 - Output Swings to Ground While Sinking Current
- **Input Offset Voltage**
 - 150 μV Max at 25°C for LT1013A
- **Offset-Voltage Temperature Coefficient**
 - 2.5 $\mu\text{V}/^\circ\text{C}$ Max for LT1013A
- **Input Offset Current**
 - 0.8 nA Max at 25°C for LT1013A
- **High Gain . . . 1.5 V/ μV Min ($R_L = 2\text{ k}\Omega$), 0.8 V/ μV Min ($R_L = 600\text{ k}\Omega$) for LT1013A**
- **Low Supply Current . . . 0.5 mA Max at $T_A = 25^\circ\text{C}$ for LT1013A**
- **Low Peak-to-Peak Noise Voltage . . . 0.55 μV Typ**
- **Low Current Noise . . . 0.07 $\text{pA}/\sqrt{\text{Hz}}$ Typ**

description/ordering information

The LT1013 devices are dual precision operational amplifiers, featuring high gain, low supply current, low noise, and low-offset-voltage temperature coefficient.

The LT1013 devices can be operated from a single 5-V power supply; the common-mode input voltage range includes ground, and the output can also swing to within a few millivolts of ground. Crossover distortion is eliminated. The LT1013 can be operated with both dual $\pm 15\text{-V}$ and single 5-V supplies.

The LT1013C, LT1013AC, and LT1013D are characterized for operation from 0°C to 70°C. The LT1013I, LT1013AI, and LT1013DI are characterized for operation from –40°C to 105°C. The LT1013M, LT1013AM, and LT1013DM are characterized for operation over the full military temperature range of –55°C to 125°C.

LT1013, LT1013D . . . D PACKAGE
(TOP VIEW)

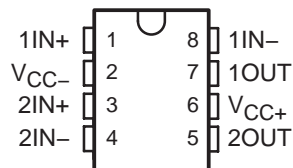

LT1013, LT1013A . . . FK PACKAGE
(TOP VIEW)

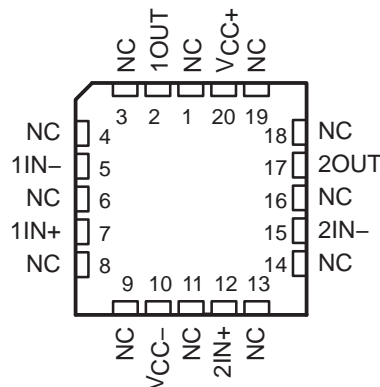

NC – No internal connection

LT1013, LT1013D . . . JG OR P PACKAGE
(TOP VIEW)

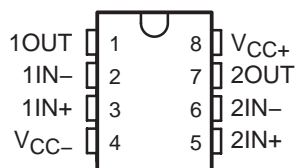

Please be aware that an important notice concerning availability, standard warranty, and use in critical applications of Texas Instruments semiconductor products and disclaimers thereto appears at the end of this data sheet.

PRODUCTION DATA information is current as of publication date. Products conform to specifications per the terms of Texas Instruments standard warranty. Production processing does not necessarily include testing of all parameters.

 **TEXAS
INSTRUMENTS**

POST OFFICE BOX 655303 • DALLAS, TEXAS 75265

Copyright © 2004, Texas Instruments Incorporated
On products compliant to MIL-PRF-38535, all parameters are tested unless otherwise noted. On all other products, production processing does not necessarily include testing of all parameters.

LT1013, LT1013A, LT1013D DUAL PRECISION OPERATIONAL AMPLIFIERS

SLOS018H – MAY 1988 – REVISED NOVEMBER 2004

ORDERING INFORMATION

TA	V _{IO} max AT 25°C (μV)	PACKAGE†		ORDERABLE PART NUMBER	TOP-SIDE MARKING
0°C to 70°C	300	P-DIP (P)	Tube of 50	LT1013CP	LT1013P
		SOIC (D)	Tube of 75	LT1013CD	1013C
			Reel of 2500	LT1013CDR	
	800	P-DIP (P)	Tube of 50	LT1013DP	LT1013DP
		SOIC (D)	Tube of 75	LT1013DD	1013D
			Reel of 2500	LT1013DDR	
-40°C to 105°C	800	P-DIP (P)	Tube of 50	LT1013DIP	LT1013DIP
		SOIC (D)	Tube of 75	LT1013DID	1013DI
			Reel of 2500	LT1013DIDR	
-55°C to 125°C	150	C-DIP (JG)	Tube of 50	LT1013AMJG	LT1013AMJG
		C-DIP (JGB)	Tube of 50	LT1013AMJGB	LT1013AMJGB
		LCCC (FK)	Tube of 55	LT1013AMFK	LT1013AMFK
		LCCC (FKB)	Tube of 55	LT1013AMFKB	LT1013AMFKB
	300	C-DIP (JG)	Tube of 50	LT1013MJG	LT1013MJG
		C-DIP (JGB)	Tube of 50	LT1013MJGB	LT1013MJGB
		LCCC (FKB)	Tube of 55	LT1013MFKB	LT1013MFKB
	800	SOIC (D)	Tube of 75	LT1013DMD	1013DM

† Package drawings, standard packing quantities, thermal data, symbolization, and PCB design guidelines are available at www.ti.com/sc/package.



POST OFFICE BOX 655303 • DALLAS, TEXAS 75265

LT1013, LT1013A, LT1013D DUAL PRECISION OPERATIONAL AMPLIFIERS

SLOS018H – MAY 1988 – REVISED NOVEMBER 2004

absolute maximum ratings over operating free-air temperature range (unless otherwise noted) †

Supply voltage (see Note 1): V_{CC+}	22 V
V_{CC-}	-22 V
Input voltage range, V_I (any input, see Note 1)	$V_{CC-} - 5\text{ V}$ to V_{CC+}
Differential input voltage (see Note 2)	$\pm 30\text{ V}$
Duration of short-circuit current at (or below) 25°C (see Note 3)	Unlimited
Package thermal impedance, θ_{JA} (see Notes 4 and 5): D package	97°C/W
P package	85°C/W
Operating virtual junction temperature, T_J	150°C
Case temperature for 60 seconds: FK package	260°C
Lead temperature 1,6 mm (1/16 inch) from case for 10 seconds: JG package	300°C
Storage temperature range, T_{stg}	-65°C to 150°C

† Stresses beyond those listed under “absolute maximum ratings” may cause permanent damage to the device. These are stress ratings only, and functional operation of the device at these or any other conditions beyond those indicated under “recommended operating conditions” is not implied. Exposure to absolute-maximum-rated conditions for extended periods may affect device reliability.

- NOTES:
1. All voltage values, except differential voltages, are with respect to the midpoint between V_{CC+} and V_{CC-} .
 2. Differential voltages are at $IN+$ with respect to $IN-$.
 3. The output may be shorted to either supply.
 4. Maximum power dissipation is a function of $T_J(\text{max})$, θ_{JA} , and T_A . The maximum allowable power dissipation at any allowable ambient temperature is $P_D = (T_J(\text{max}) - T_A) / \theta_{JA}$. Operating at the absolute maximum T_J of 150°C can affect reliability. Due to variation in individual device electrical characteristics and thermal resistance, the built-in thermal overload protection may be activated at power levels slightly above or below the rated dissipation.
 5. The package thermal impedance is calculated in accordance with JESD 51-7.



LT1013, LT1013A, LT1013D DUAL PRECISION OPERATIONAL AMPLIFIERS

SLOS018H – MAY 1988 – REVISED NOVEMBER 2004

electrical characteristics at specified free-air temperature, $V_{CC\pm} = \pm 15\text{ V}$, $V_{IC} = 0$ (unless otherwise noted)

PARAMETER	TEST CONDITIONS	T_A †	LT1013C			LT1013AC			LT1013DC			UNIT
			MIN	TYP‡	MAX	MIN	TYP‡	MAX	MIN	TYP‡	MAX	
V_{IO}	$R_S = 50\ \Omega$	25°C	60	300	150	40	150	200	800		μV	
		Full range		400	240				1000			
$\alpha_{V_{IO}}$		Full range	0.4	2.5	2	0.3	2	0.7	5		$\mu\text{V}/^\circ\text{C}$	
		25°C	0.5			0.4		0.5				
		25°C	0.2	1.5	0.8	0.15	0.8	0.2	1.5		nA	
	Full range		2.8	1.5				2.8				
I_{IB}		25°C	-15	-30	-20	-12	-20	-15	-30		nA	
		Full range		-38	-25			-38				
V_{ICR}	Common-mode input voltage range	25°C	-15 to 13.5	-15.3 to 13.8	-15 to 13.8	-15 to 13.5	-15.3 to 13.8	-15 to 13.5	-15.3 to 13.8		V	
		Full range		-15 to 13		-15 to 13		-15 to 13				
V_{OM}	Maximum peak output voltage swing	25°C	± 12.5	± 14	± 14	± 13	± 14	± 12.5	± 14		V	
		Full range		± 12		± 12.5		± 12				
A_{VD}	Large-signal differential voltage amplification	25°C	0.5	0.2	2.5	0.8	2.5	0.5	2		$\text{V}/\mu\text{V}$	
		25°C	1.2	7	8	1.5	8	1.2	7			
		Full range	0.7		1			0.7				
CMRR	Common-mode rejection ratio	25°C	97	114	117	100	117	97	114		dB	
		Full range	94			98		94				
kSVR	Supply-voltage rejection ratio ($\Delta V_{CC}/\Delta V_{IO}$)	25°C	100	117	120	103	120	100	117		dB	
		Full range	97			101		97				
r_{Id}	Channel separation	25°C	120	137	140	123	140	120	137		dB	
r_{Id}	Differential input resistance	25°C	70	300	400	100	400	70	300		$\text{M}\Omega$	
r_{IC}	Common-mode input resistance	25°C	4		5			4			$\text{G}\Omega$	
ICC	Supply current per amplifier	25°C	0.35	0.55	0.5	0.35	0.5	0.35	0.55		mA	
		Full range		0.7	0.55			0.6				

† Full range is 0°C to 70°C.

‡ All typical values are at $T_A = 25^\circ\text{C}$.



LT1013, LT1013A, LT1013D DUAL PRECISION OPERATIONAL AMPLIFIERS

SLOS018H – MAY 1988 – REVISED NOVEMBER 2004

electrical characteristics at specified free-air temperature, $V_{CC+} = 5\text{ V}$, $V_{CC-} = 0$, $V_O = 1.4\text{ V}$, $V_{IC} = 0$ (unless otherwise noted)

PARAMETER	TEST CONDITIONS	T _A †	LT1013C			LT1013AC			LT1013DC			UNIT	
			MIN	TYP‡	MAX	MIN	TYP‡	MAX	MIN	TYP‡	MAX		
V _{IO} Input offset voltage	R _S = 50 Ω	25°C	90	450	450	60	250	250	250	950	950	μV	
		Full range		570		350		1200					
I _{IO} Input offset current		25°C	0.3	2	2	0.2	1.3	1.3	0.3	2	2	nA	
		Full range		6		3.5		6					
I _{IB} Input bias current		25°C	-18	-50	-50	-15	-35	-35	-18	-50	-50	nA	
		Full range		-90		-55		-90					
V _{ICR} Common-mode input voltage range		25°C	0	-0.3	0	0	-0.3	0	0	-0.3	0	V	
		Full range	0	to 3.5	to 3.8	0	to 3.5	to 3.8	0	to 3.5	to 3.8		
V _{OM} Maximum peak output voltage swing	Output low, No load	25°C	15	25	25	15	25	25	15	25	25	mV	
		25°C	5	10	10	5	10	10	5	10	10		
	Output low, R _L = 600 Ω to GND		25°C		13	13		13	13		13	13	mV
			Full range		220	350	220	350	350	220	350	350	
	Output high, No load		25°C	4	4.4	4.4	4	4.4	4.4	4	4.4	4.4	V
			25°C	3.4	4	4	3.4	4	4	3.4	4	4	
Output high, R _L = 600 Ω to GND		25°C	3.2			3.3			3.2			V	
		Full range		1		1				1			
A _{VD} Large-signal differential voltage amplification	V _O = 5 mV to 4 V, R _L = 500 Ω	25°C										V/μV	
I _{CC} Supply current per amplifier		25°C	0.32	0.5	0.5	0.31	0.45	0.45	0.32	0.5	0.5	mA	
		Full range		0.55				0.55					

† Full range is 0°C to 70°C.

‡ All typical values are at T_A = 25°C.

operating characteristics, $V_{CC\pm} = \pm 15\text{ V}$, $V_{IC} = 0$, T_A = 25°C

PARAMETER	TEST CONDITIONS	MIN	TYP	MAX	UNIT
SR Slew rate		0.2	0.4		V/μs
V _n Equivalent input noise voltage	f = 10 Hz		24		nV/√Hz
	f = 1 kHz		22		nV/√Hz
V _{N(PP)} Peak-to-peak equivalent input noise voltage	f = 0.1 Hz to 10 Hz		0.55		μV
I _n Equivalent input noise current	f = 10 Hz		0.07		pA/√Hz

LT1013, LT1013A, LT1013D DUAL PRECISION OPERATIONAL AMPLIFIERS

SLOS018H – MAY 1988 – REVISED NOVEMBER 2004

electrical characteristics at specified free-air temperature, $V_{CC\pm} = \pm 15\text{ V}$, $V_{IC} = 0$ (unless otherwise noted)

PARAMETER	TEST CONDITIONS	T _A †	LT1013I			LT1013AI			LT1013DI			UNIT
			MIN	TYP‡	MAX	MIN	TYP‡	MAX	MIN	TYP‡	MAX	
V _{IO}	R _S = 50 Ω	25°C	60	300	40	150	200	800				μV
		Full range			550	300		1000				
α _{V_{IO}}		Full range	0.4	2.5	0.3	2	0.7	5				μV/°C
		25°C	0.5		0.4		0.5					μV/mo
I _{IO}		25°C	0.2	1.5	0.15	0.8	0.2	1.5				nA
		Full range		2.8	1.5		2.8					
I _{IB}		25°C	-15	-30	-12	-20	-15	-30				nA
		Full range		-38	-25		-38					
V _{ICR}		25°C	-15 to 13.5	-15.3 to 13.8	-15 to 13.5	-15.3 to 13.8	-15 to 13.5	-15.3 to 13.8				V
		Full range	-15 to 13		-15 to 13							
V _{OM}		25°C	±12.5	±14	±13	±14	±12.5	±14				V
	R _L = 2 kΩ	Full range	±12		±12.5		±12					
A _{VD}		25°C	0.5	0.2	0.8	2.5	0.5	2				V/μV
	V _O = ±10 V, R _L = 600 Ω	25°C	1.2	7	1.5	8	1.2	7				
	V _O = ±10 V, R _L = 2 kΩ	Full range	0.7		1		0.7					
CMRR		25°C	97	114	100	117	97	114				dB
	V _{IC} = -15 V to 13.5 V	Full range	94		97		94					
k _{SVR}		25°C	100	117	103	120	100	117				dB
	V _{IC} = -14.9 V to 13 V	Full range	97		101		97					
r _{id}		25°C	120	137	123	140	120	137				dB
	V _O = ±10 V, R _L = 2 kΩ	25°C	70	300	100	400	70	300				
r _{ic}		25°C	4		5		4					MΩ
I _{CC}		25°C	0.35	0.55	0.35	0.5	0.35	0.55				mA
	Supply current per amplifier	Full range		0.7		0.55		0.6				

† Full range is -40°C to 105°C.

‡ All typical values are at T_A = 25°C.



LT1013, LT1013A, LT1013D DUAL PRECISION OPERATIONAL AMPLIFIERS

SLOS018H – MAY 1988 – REVISED NOVEMBER 2004

electrical characteristics at specified free-air temperature, $V_{CC+} = 5\text{ V}$, $V_{CC-} = 0$, $V_O = 1.4\text{ V}$, $V_{IC} = 0$ (unless otherwise noted)

PARAMETER	TEST CONDITIONS	T _A †	LT1013I			LT1013AI			LT1013DI			UNIT
			MIN	TYP‡	MAX	MIN	TYP‡	MAX	MIN	TYP‡	MAX	
V _{IO} Input offset voltage	R _S = 50 Ω	25°C	90	450	250	60	250	250	950	950	μV	
		Full range		570	350		1200					
I _{IO} Input offset current		25°C	0.3	2	1.3	0.2	1.3	0.3	2	nA		
		Full range		6	3.5		6					
I _{IB} Input bias current		25°C	-18	-50	-35	-15	-35	-18	-50	nA		
		Full range		-90	-55		-90					
V _{ICR} Common-mode input voltage range		25°C	0 to 3.5	-0.3 to 3.8	0 to 3.5	-0.3 to 3.8	0 to 3.5	-0.3 to 3.8	0 to 3.5	-0.3 to 3.8	V	
		Full range	0 to 3		0 to 3		0 to 3		0 to 3			
V _{OM} Maximum peak output voltage swing	Output low, No load Output low, R _L = 600 Ω to GND Output low, I _{sink} = 1 mA Output high, No load Output high, R _L = 600 Ω to GND	25°C	15	25	15	25	15	25	15	25	mV	
		25°C	5	10	5	10	5	10	5	10		
		Full range		13		13		13		13		
		25°C	220	350	220	350	220	350	220	350		
		25°C	4	4.4	4	4.4	4	4.4	4	4.4		
A _{VD} Large-signal differential voltage amplification	V _O = 5 mV to 4 V, R _L = 500 Ω	25°C	3.4	4	3.4	4	3.4	4	3.4	4	V	
		Full range	3.2		3.3		3.2		3.2			
I _{CC} Supply current per amplifier		25°C	1		1		1		1	V/μV		
		25°C	0.32	0.5	0.31	0.45	0.32	0.5	0.32	0.5	mA	
Full range			0.55		0.5		0.55		0.55			

† Full range is -40°C to 105°C.

‡ All typical values are at T_A = 25°C.

operating characteristics, $V_{CC\pm} = \pm 15\text{ V}$, $V_{IC} = 0$, T_A = 25°C

PARAMETER	TEST CONDITIONS	MIN	TYP	MAX	UNIT
SR Slew rate		0.2	0.4		V/μs
V _n Equivalent input noise voltage	f = 10 Hz		24		nV/√Hz
	f = 1 kHz		22		
V _{N(PP)} Peak-to-peak equivalent input noise voltage	f = 0.1 Hz to 10 Hz		0.55		μV
I _n Equivalent input noise current	f = 10 Hz		0.07		pA/√Hz



LT1013, LT1013A, LT1013D DUAL PRECISION OPERATIONAL AMPLIFIERS

SLOS018H – MAY 1988 – REVISED NOVEMBER 2004

electrical characteristics at specified free-air temperature, $V_{CC\pm} = \pm 15\text{ V}$, $V_{IC} = 0$ (unless otherwise noted)

PARAMETER	TEST CONDITIONS	T_A †	LT1013M			LT1013AM			LT1013DM			UNIT
			MIN	TYP‡	MAX	MIN	TYP‡	MAX	MIN	TYP‡	MAX	
V_{IO}	$R_S = 50\ \Omega$	25°C	60	300	40	150	800	200	800	1000	μV	
$\alpha_{V_{IO}}$	Full range	Full range	0.5	2.5*	0.4	2*	0.5	2.5*	0.5	2.5*	$\mu\text{V}/^\circ\text{C}$	
			0.5	0.5	0.4	0.4	0.5				$\mu\text{V}/\text{mo}$	
I_{IO}		25°C	0.2	1.5	0.15	0.8	1.5	0.2	1.5	5	nA	
I_{IB}	Full range	Full range	-15	-30	-12	-20	-15	-30	-15	-30	-45	nA
			-15	-15.3 to 13.8	-15	-15.3 to 13.8	-14.9 to 13	-14.9 to 13	-15	-15.3 to 13.8	-14.9 to 13	
V_{ICR}	Common-mode input voltage range	25°C	-15 to 13.5	-15.3 to 13.8	-15 to 13.5	-15.3 to 13.8	-14.9 to 13	-14.9 to 13	-15 to 13.5	-15.3 to 13.8	V	
V_{OM}	Maximum peak output voltage swing	25°C	± 12.5	± 14	± 13	± 14	± 12.5	± 14	± 12.5	± 14	V	
			± 11.5		± 12		± 11.5					
A_{VD}	Large-signal differential voltage amplification	25°C	0.5	2	0.8	2.5	0.5	2	0.5	2	$\text{V}/\mu\text{V}$	
			1.2	7	1.5	8	1.2	7	0.25	0.25		
CMRR	Common-mode rejection ratio	25°C	97	117	100	117	97	114	97	114	dB	
			94		97		94		94			
kSVR	Supply-voltage rejection ratio ($\Delta V_{CC}/\Delta V_{IO}$)	25°C	100	117	103	120	100	117	100	117	dB	
			97		100		97		97			
r_{Id}	Channel separation	25°C	120	137	123	140	120	137	120	137	dB	
			70	300	100	400	70	300	70	300	M Ω	
r_{IC}	Common-mode input resistance	25°C	4	4	5	5	4	4	4	4	G Ω	
			0.35	0.55	0.35	0.5	0.35	0.55	0.35	0.55	0.7	
ICC	Supply current per amplifier	25°C	0.35	0.55	0.35	0.5	0.35	0.55	0.35	0.55	mA	
			0.7	0.7	0.6	0.6	0.7	0.7	0.6	0.6	0.7	

* On products compliant to MIL-PRF-38535, Class B, this parameter is not production tested.

† Full range is -55°C to 125°C.

‡ All typical values are at $T_A = 25^\circ\text{C}$.



LT1013, LT1013A, LT1013D DUAL PRECISION OPERATIONAL AMPLIFIERS

SLOS018H – MAY 1988 – REVISED NOVEMBER 2004

electrical characteristics at specified free-air temperature, $V_{CC+} = 5\text{ V}$, $V_{CC-} = 0$, $V_O = 1.4\text{ V}$, $V_{IC} = 0$ (unless otherwise noted)

PARAMETER	TEST CONDITIONS	T _A †	LT1013M			LT1013AM			LT1013DM			UNIT
			MIN	TYP‡	MAX	MIN	TYP‡	MAX	MIN	TYP‡	MAX	
V _{IO} Input offset voltage	R _S = 50 Ω	25°C	90	450	60	250	250	950	250	950	μV	
		Full range	400	1500	250	900	800	2000	800	2000		
I _{IO} Input offset current	R _S = 50 Ω, V _{IC} = 0.1 V	125°C	200	750	120	450	560	1200	560	1200	nA	
		25°C	0.3	2	0.2	1.3	0.3	2	0.3	2		
I _{IB} Input bias current	Full range	25°C	10	6	10	6	10	6	10	6	nA	
		Full range	-18	-50	-15	-35	-18	-50	-18	-50		
V _{ICR} Common-mode input voltage range	Full range	25°C	-120	-80	-120	-80	-120	-80	-120	-80	nA	
		Full range	-120	-80	-120	-80	-120	-80	-120	-80		
V _{OM} Maximum peak output voltage swing	Output low, No load	25°C	0	-0.3	0	-0.3	0	-0.3	0	-0.3	V	
		Full range	to 3.5	to 3.8	to 3.5	to 3.8	to 3.5	to 3.8	to 3.5	to 3.8		
V _{OM} Maximum peak output voltage swing	Output low, R _L = 600 Ω to GND	25°C	15	25	15	25	15	25	15	25	mV	
		Full range	5	10	5	10	5	10	5	10		
	Output high, No load	25°C	220	350	220	350	220	350	220	350		
		Full range	4	4.4	4	4.4	4	4.4	4	4.4		
	Output high, R _L = 600 Ω to GND	25°C	3.4	4	3.4	4	3.4	4	3.4	4	V	
		Full range	3.1	3.2	3.1	3.2	3.1	3.2	3.1	3.2		
A _V D Large-signal differential voltage amplification	V _O = 5 mV to 4 V, R _L = 500 Ω	25°C	1	1	1	1	1	1	1	1	V/μV	
		Full range	0.32	0.5	0.31	0.45	0.32	0.5	0.32	0.5		
I _{CC} Supply current per amplifier	Full range	25°C	0.32	0.5	0.31	0.45	0.32	0.5	0.32	0.5	mA	
		Full range	0.65	0.65	0.65	0.65	0.65	0.65	0.65	0.65		

† Full range is -55°C to 125°C.

‡ All typical values are at T_A = 25°C.

operating characteristics, V_{CC±} = ±15 V, V_{IC} = 0, T_A = 25°C

PARAMETER	TEST CONDITIONS	MIN	TYP	MAX	UNIT
SR Slew rate		0.2	0.4		V/μs
V _n Equivalent input noise voltage	f = 10 Hz		24		nV/√Hz
	f = 1 kHz		22		nV/√Hz
V _{N(PP)} Peak-to-peak equivalent input noise voltage	f = 0.1 Hz to 10 Hz		0.55		μV
I _n Equivalent input noise current	f = 10 Hz		0.07		pA/√Hz



TYPICAL CHARACTERISTICS

Table of Graphs

			FIGURE
V_{IO}	Input offset voltage	vs Supply voltage	1
		vs Temperature	2
ΔV_{IO}	Change in input offset voltage	vs Time	3
I_{IO}	Input offset current	vs Temperature	4
I_{IB}	Input bias current	vs Temperature	5
V_{IC}	Common-mode input voltage	vs Input bias current	6
A_{VD}	Differential voltage amplification	vs Load resistance	7, 8
		vs Frequency	9, 10
	Channel separation	vs Frequency	11
	Output saturation voltage	vs Temperature	12
CMRR	Common-mode rejection ratio	vs Frequency	13
k_{SVR}	Supply-voltage rejection ratio	vs Frequency	14
I_{CC}	Supply current	vs Temperature	15
I_{OS}	Short-circuit output current	vs Time	16
V_n	Equivalent input noise voltage	vs Frequency	17
I_n	Equivalent input noise current	vs Frequency	17
$V_{N(PP)}$	Peak-to-peak input noise voltage	vs Time	18
	Pulse response	Small signal	19, 21
		Large signal	20, 22, 23
	Phase shift	vs Frequency	9

LT1013, LT1013A, LT1013D DUAL PRECISION OPERATIONAL AMPLIFIERS

SLOS018H – MAY 1988 – REVISED NOVEMBER 2004

TYPICAL CHARACTERISTICS†

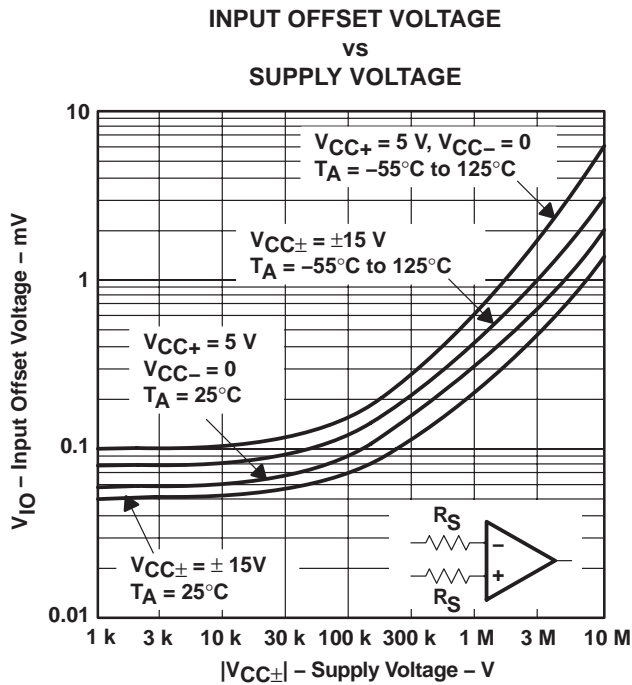

Figure 1

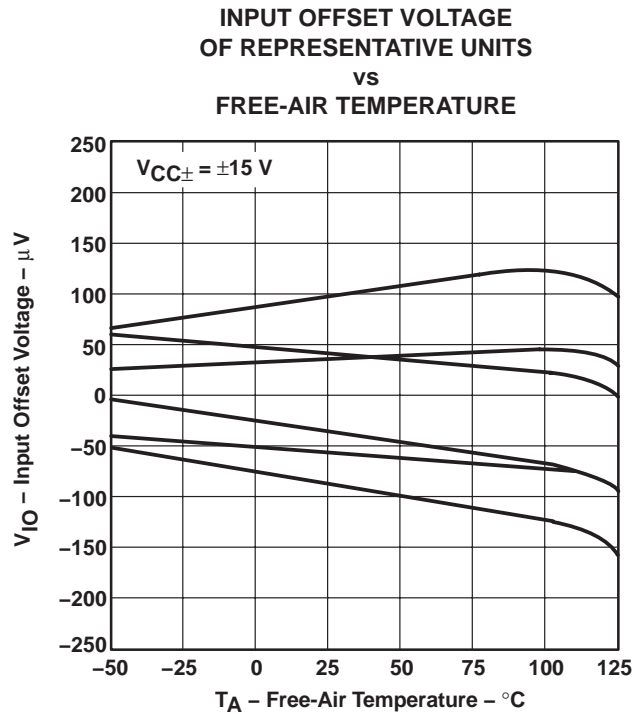

Figure 2

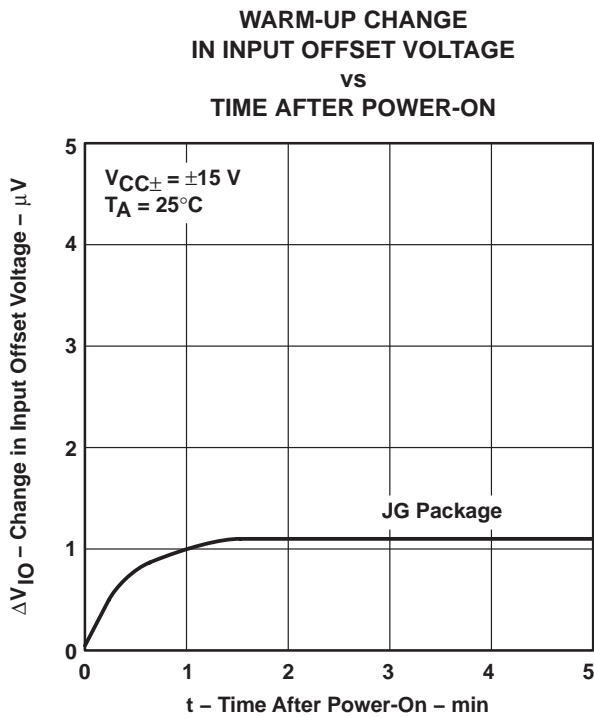

Figure 3

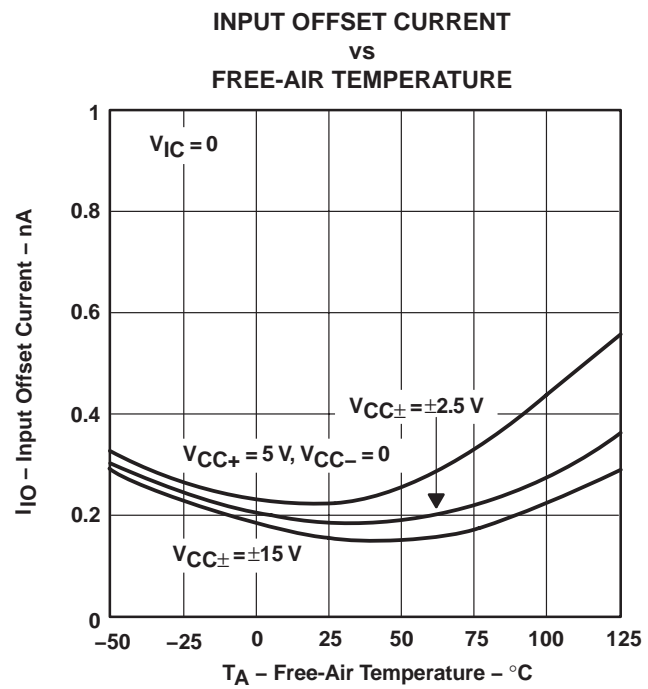

Figure 4

† Data at high and low temperatures are applicable only within the rated operating free-air temperature ranges of the various devices.

TYPICAL CHARACTERISTICS†

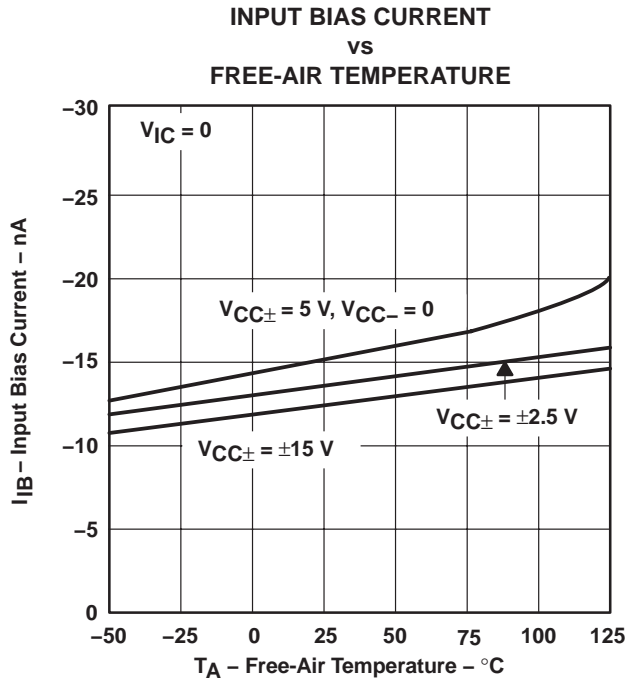

Figure 5

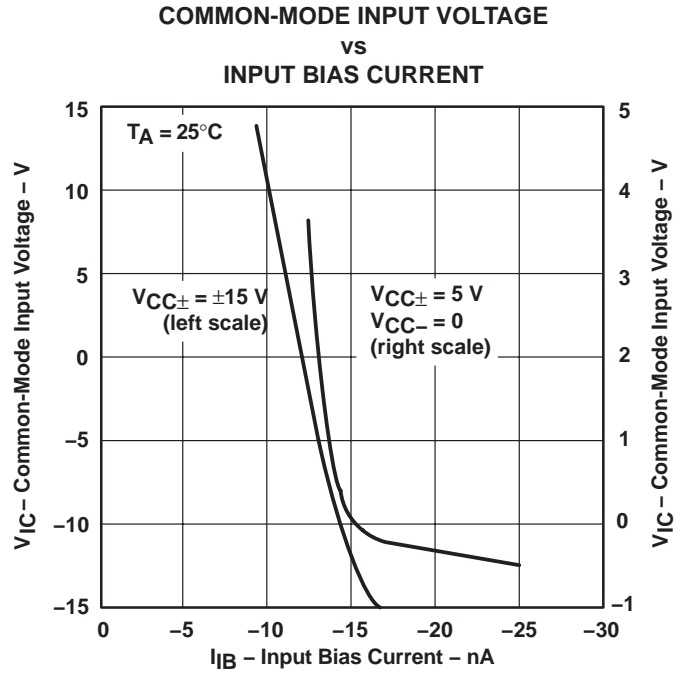

Figure 6

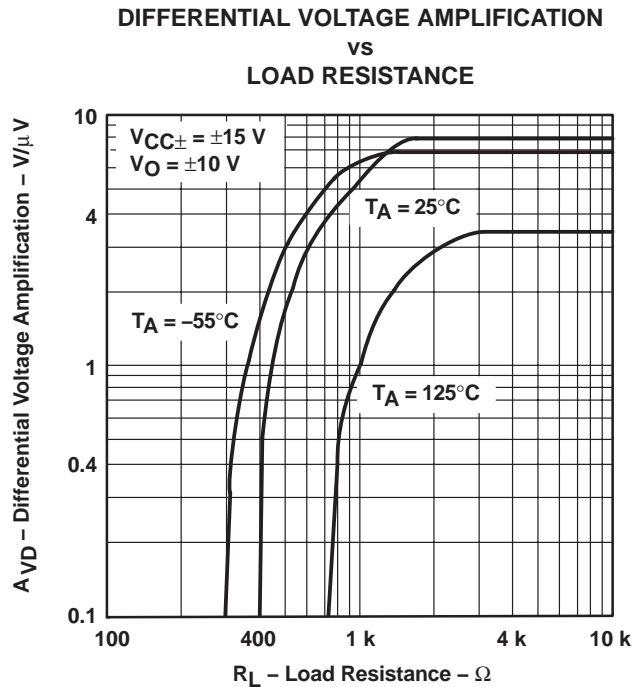

Figure 7

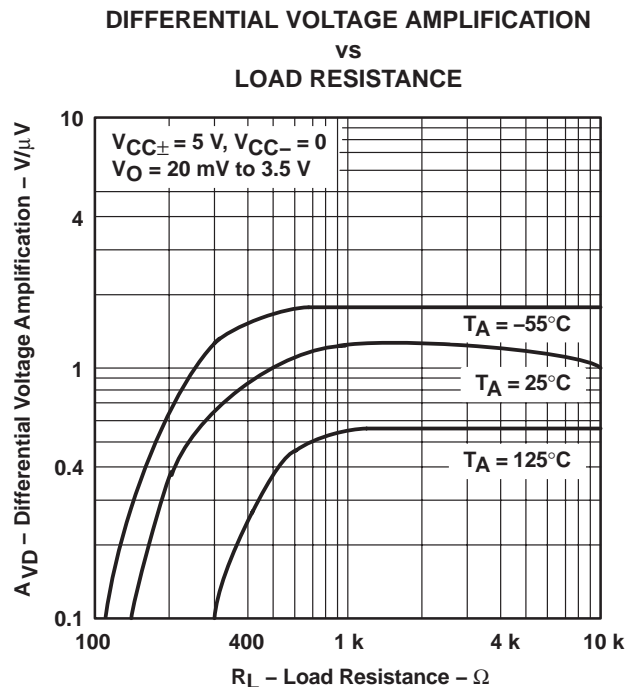

Figure 8

† Data at high and low temperatures are applicable only within the rated operating free-air temperature ranges of the various devices.

LT1013, LT1013A, LT1013D DUAL PRECISION OPERATIONAL AMPLIFIERS

SLOS018H – MAY 1988 – REVISED NOVEMBER 2004

TYPICAL CHARACTERISTICS†

**DIFFERENTIAL VOLTAGE AMPLIFICATION
AND PHASE SHIFT
VS
FREQUENCY**

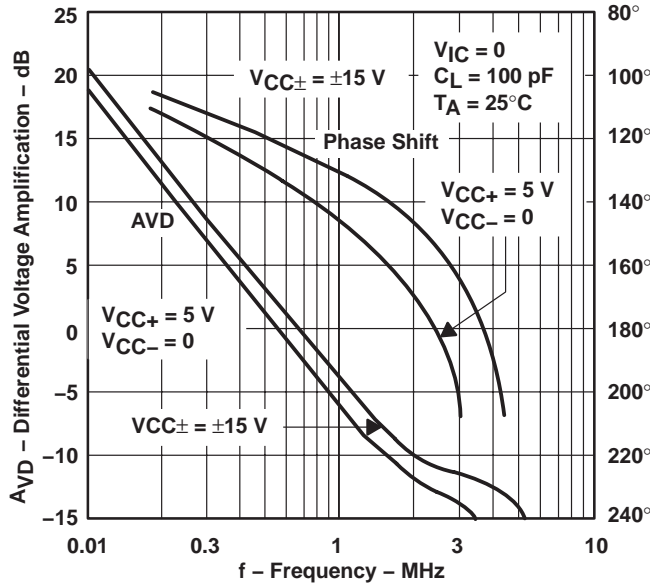

Figure 9

**DIFFERENTIAL VOLTAGE AMPLIFICATION
VS
FREQUENCY**

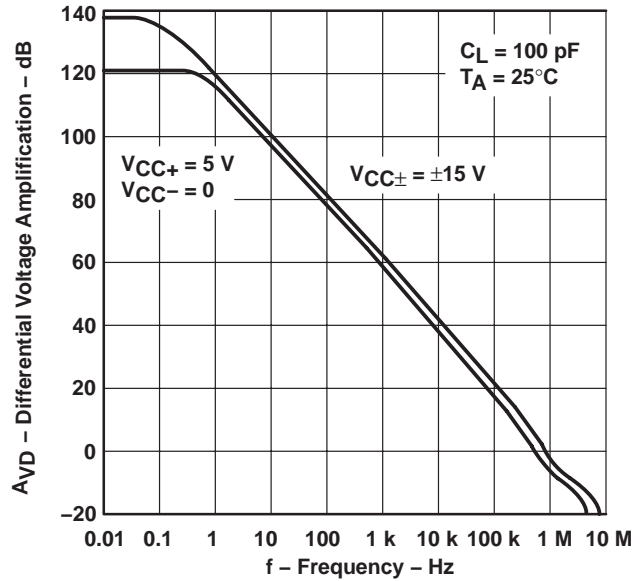

Figure 10

**CHANNEL SEPARATION
VS
FREQUENCY**

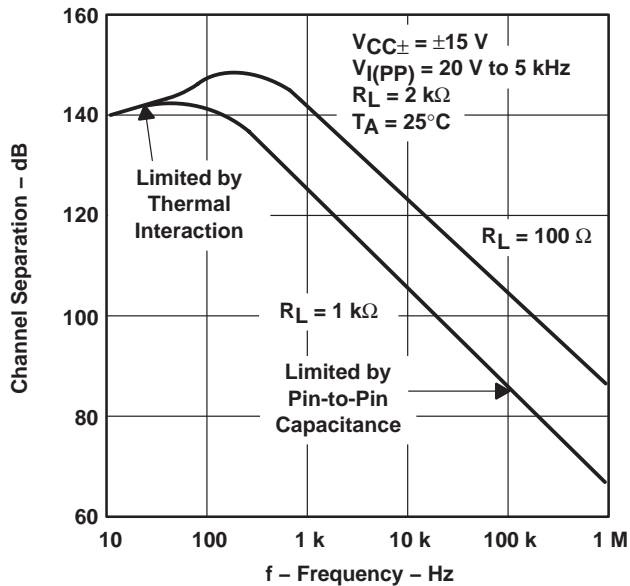

Figure 11

**OUTPUT SATURATION VOLTAGE
VS
FREE-AIR TEMPERATURE**

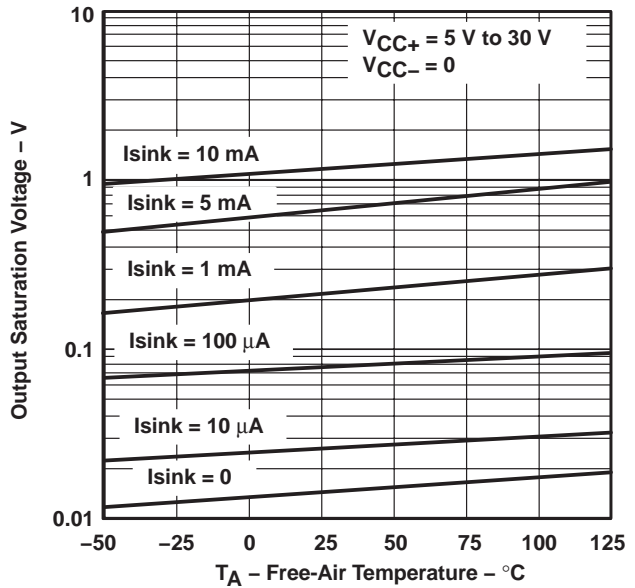

Figure 12

† Data at high and low temperatures are applicable only within the rated operating free-air temperature ranges of the various devices.

TYPICAL CHARACTERISTICS†

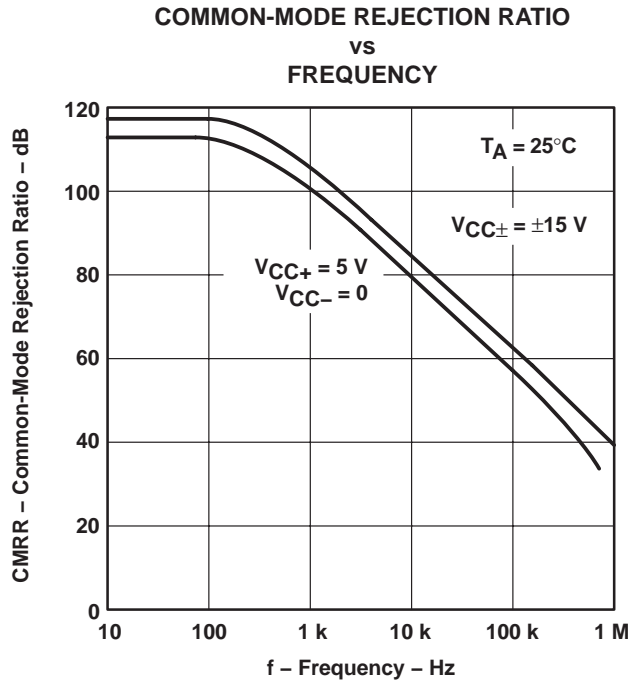

Figure 13

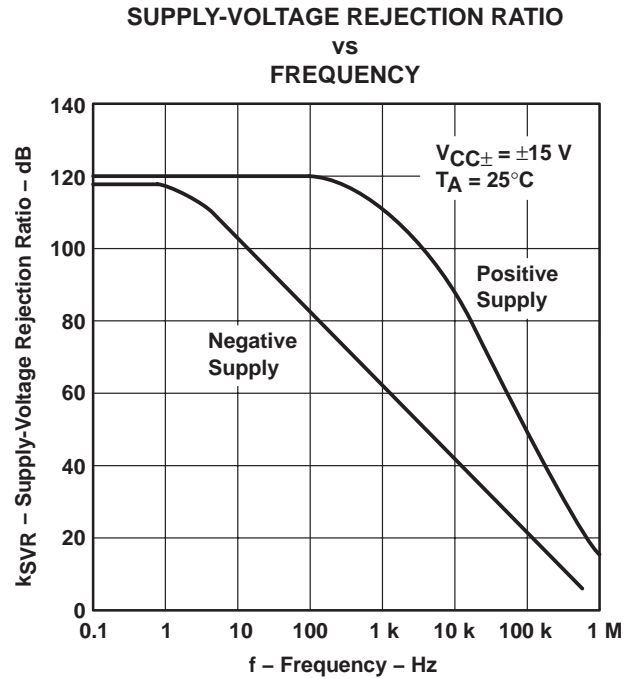

Figure 14

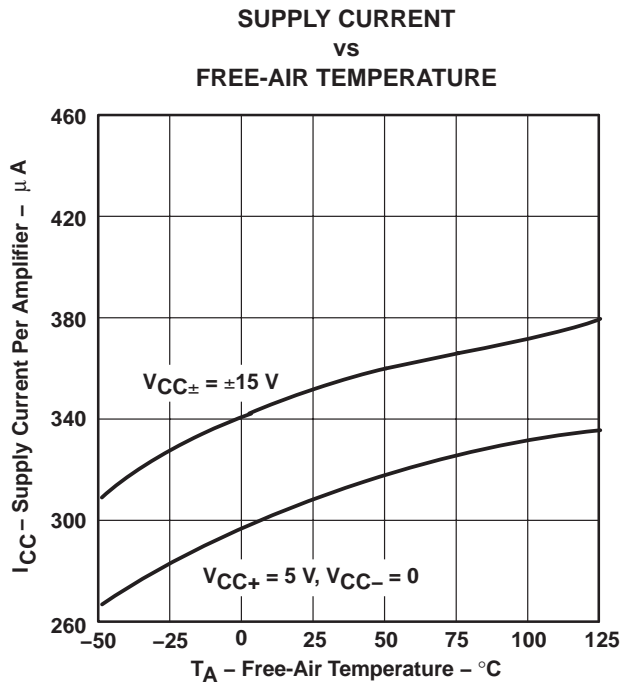

Figure 15

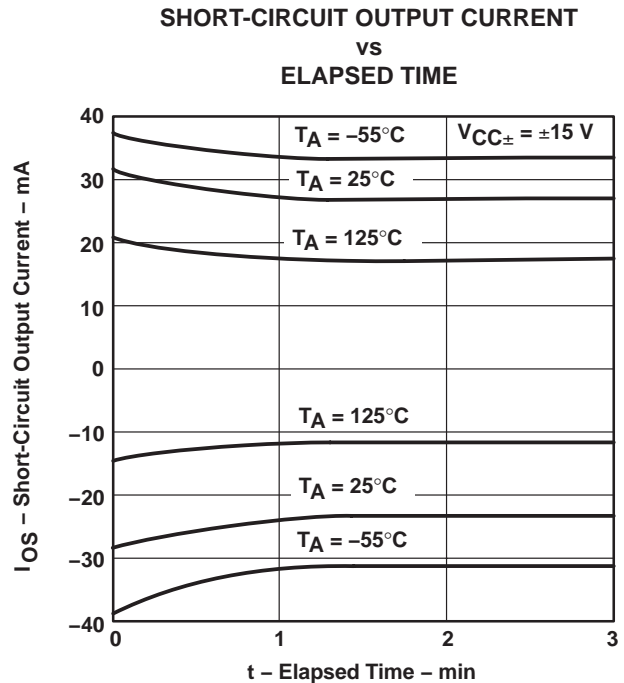

Figure 16

† Data at high and low temperatures are applicable only within the rated operating free-air temperature ranges of the various devices.

LT1013, LT1013A, LT1013D DUAL PRECISION OPERATIONAL AMPLIFIERS

SLOS018H – MAY 1988 – REVISED NOVEMBER 2004

TYPICAL CHARACTERISTICS

**EQUIVALENT INPUT NOISE VOLTAGE
AND EQUIVALENT INPUT NOISE CURRENT
VS
FREQUENCY**

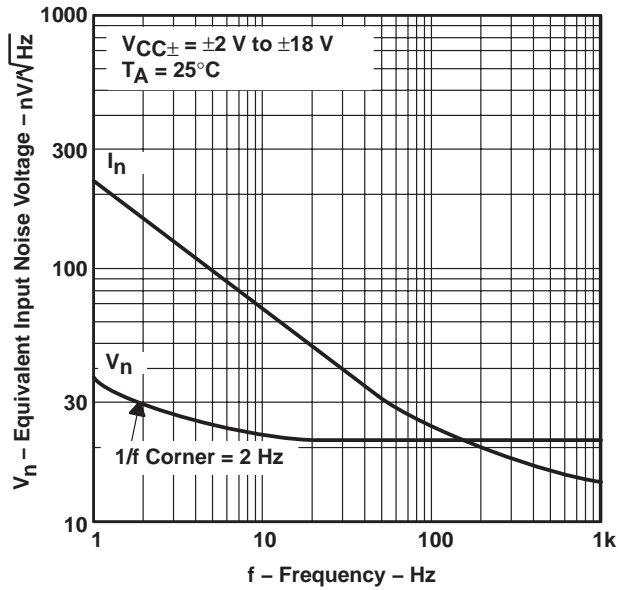

Figure 17

**PEAK-TO-PEAK INPUT NOISE VOLTAGE
OVER A
10-SECOND PERIOD**

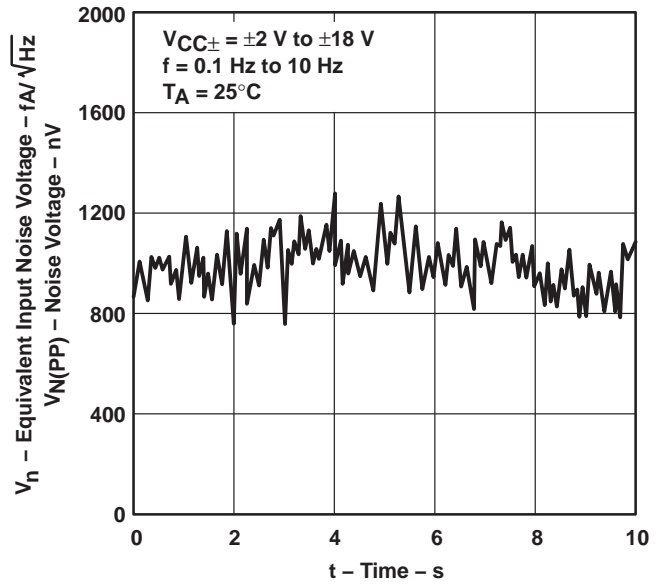

Figure 18

**VOLTAGE-FOLLOWER
SMALL-SIGNAL
PULSE RESPONSE**

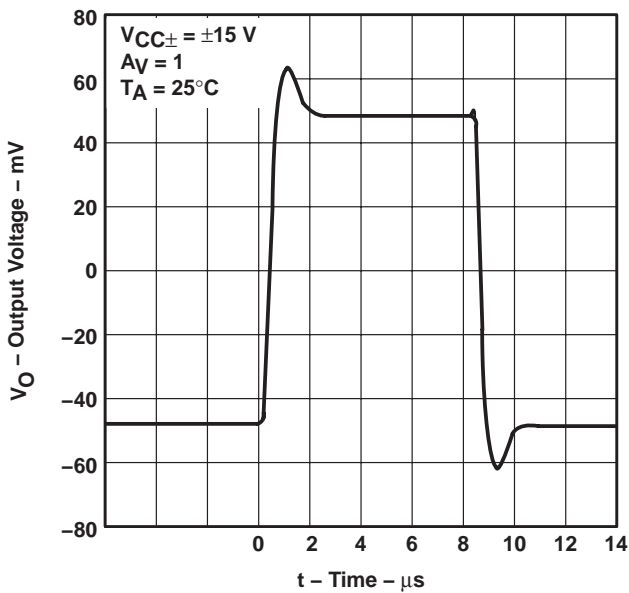

Figure 19

**VOLTAGE-FOLLOWER
LARGE-SIGNAL
PULSE RESPONSE**

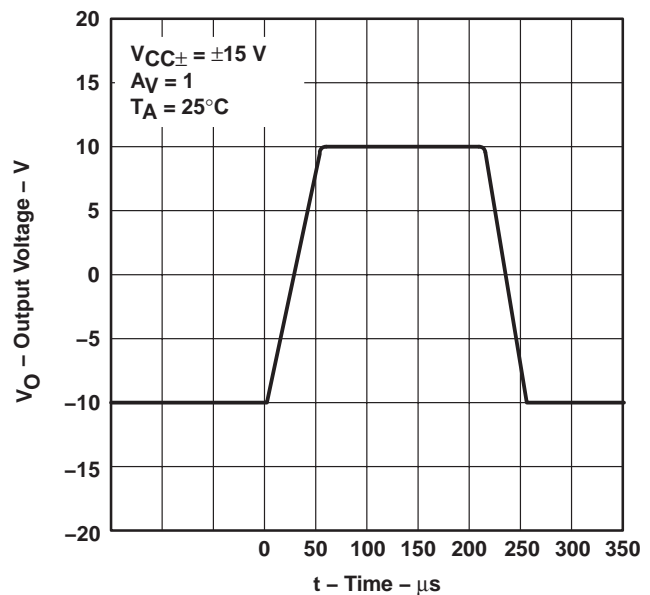

Figure 20

TYPICAL CHARACTERISTICS

VOLTAGE-FOLLOWER
 SMALL-SIGNAL
 PULSE RESPONSE

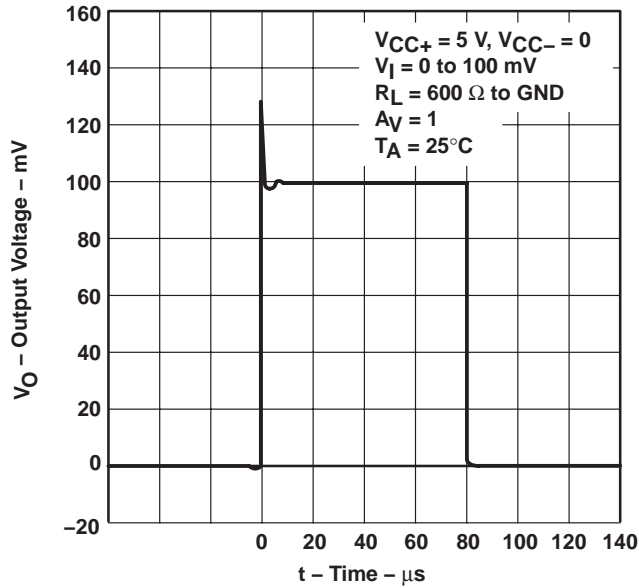

Figure 21

VOLTAGE-FOLLOWER
 LARGE-SIGNAL
 PULSE RESPONSE

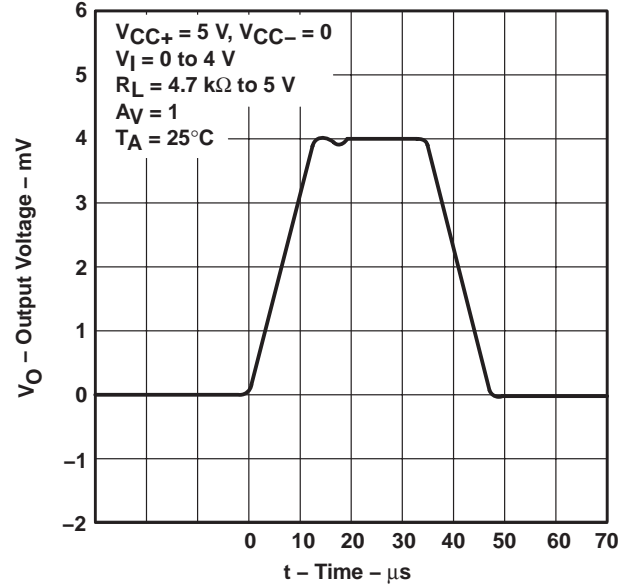

Figure 22

VOLTAGE-FOLLOWER
 LARGE-SIGNAL
 PULSE RESPONSE

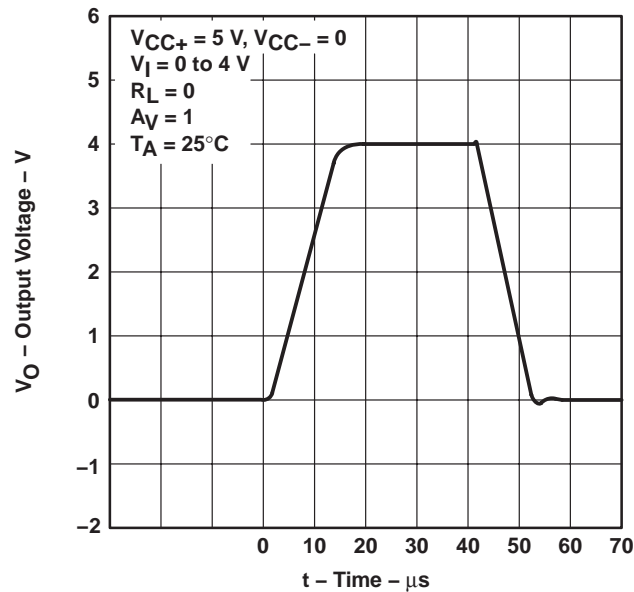

Figure 23

LT1013, LT1013A, LT1013D DUAL PRECISION OPERATIONAL AMPLIFIERS

SLOS018H – MAY 1988 – REVISED NOVEMBER 2004

APPLICATION INFORMATION

single-supply operation

The LT1013 is fully specified for single-supply operation ($V_{CC-} = 0$). The common-mode input voltage range includes ground, and the output swings to within a few millivolts of ground.

Furthermore, the LT1013 has specific circuitry that addresses the difficulties of single-supply operation, both at the input and at the output. At the input, the driving signal can fall below 0 V, either inadvertently or on a transient basis. If the input is more than a few hundred millivolts below ground, the LT1013 is designed to deal with the following two problems that can occur:

1. On many other operational amplifiers, when the input is more than a diode drop below ground, unlimited current flows from the substrate (V_{CC-} terminal) to the input, which can destroy the unit. On the LT1013, the 400- Ω resistors in series with the input [see *schematic (each amplifier)*] protect the device, even when the input is 5 V below ground.
2. When the input is more than 400 mV below ground (at $T_A = 25^\circ\text{C}$), the input stage of similar operational amplifiers saturates, and phase reversal occurs at the output. This can cause lockup in servo systems. Because of unique phase-reversal protection circuitry (Q21, Q22, Q27, and Q28), the LT1013 outputs do not reverse, even when the inputs are at -1.5 V (see Figure 24).

This phase-reversal protection circuitry does not function when the other operational amplifier on the LT1013 is driven hard into negative saturation at the output. Phase-reversal protection does not work on amplifier 1 when amplifier 2 output is in negative saturation nor on amplifier 2 when amplifier 1 output is in negative saturation.

At the output, other single-supply designs either cannot swing to within 600 mV of ground or cannot sink more than a few microamperes while swinging to ground. The all-npn output stage of the LT1013 maintains its low output resistance and high-gain characteristics until the output is saturated. In dual-supply operations, the output stage is free of crossover distortion.

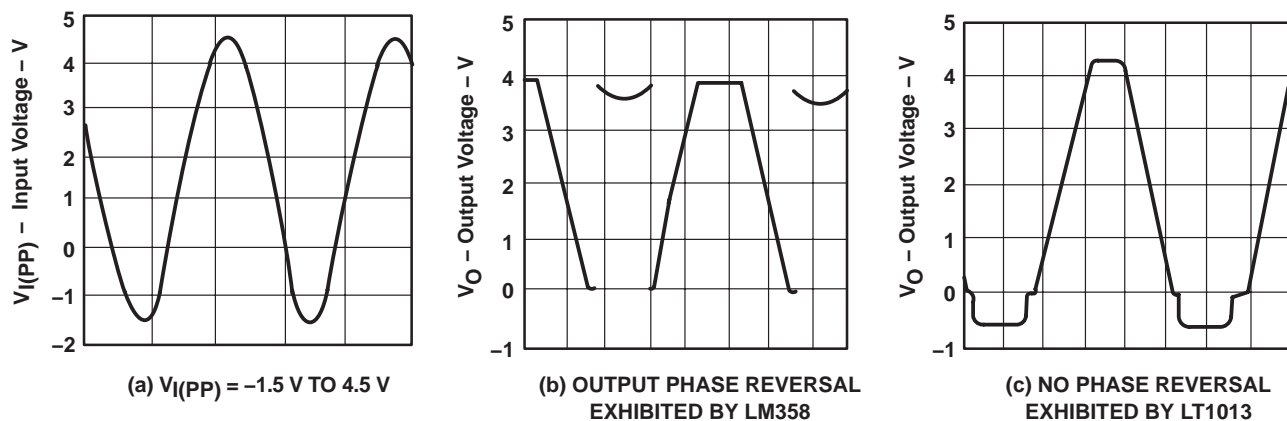

Figure 24. Voltage-Follower Response With Input Exceeding the Negative Common-Mode Input Voltage Range

APPLICATION INFORMATION

comparator applications

The single-supply operation of the LT1013 is well suited for use as a precision comparator with TTL-compatible output. In systems using both operational amplifiers and comparators, the LT1013 can perform multiple duties (see Figures 25 and 26).

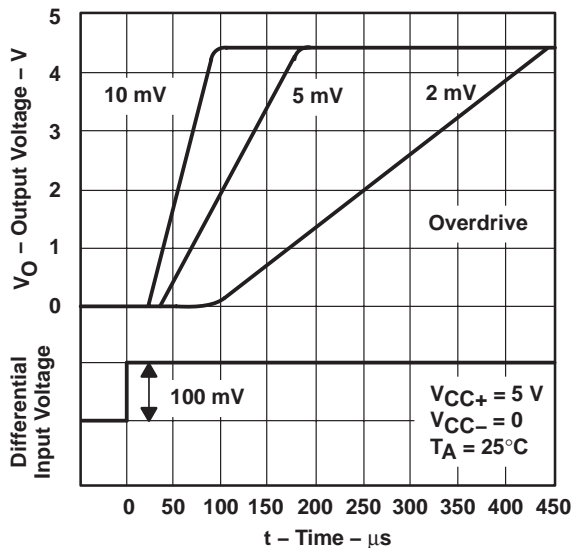

Figure 25. Low-to-High-Level Output Response for Various Input Overdrives

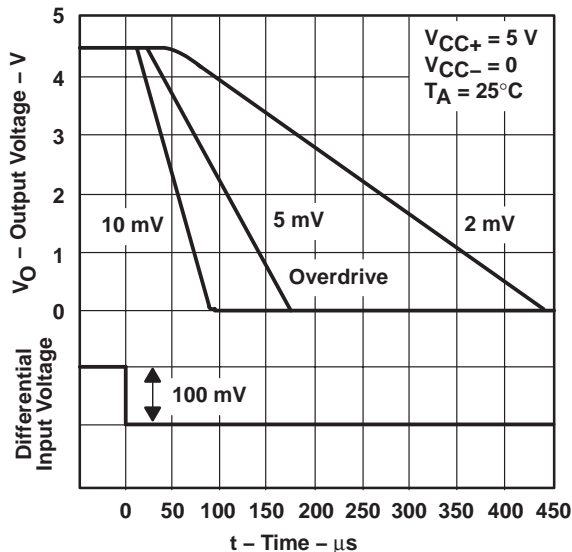

Figure 26. High-to-Low-Level Output Response for Various Input Overdrives

low-supply operation

The minimum supply voltage for proper operation of the LT1013 is 3.4 V (three NiCad batteries). Typical supply current at this voltage is 290 μ A; therefore, power dissipation is only 1 mW per amplifier.

offset voltage and noise testing

The test circuit for measuring input offset voltage and its temperature coefficient is shown in Figure 30. This circuit, with supply voltages increased to ± 20 V, also is used as the burn-in configuration.

The peak-to-peak equivalent input noise voltage of the LT1013 is measured using the test circuit shown in Figure 27. The frequency response of the noise tester indicates that the 0.1-Hz corner is defined by only one zero. The test time to measure 0.1-Hz to 10-Hz noise should not exceed 10 seconds, as this time limit acts as an additional zero to eliminate noise contribution from the frequency band below 0.1 Hz.

An input noise voltage test is recommended when measuring the noise of a large number of units. A 10-Hz input noise voltage measurement correlates well with a 0.1-Hz peak-to-peak noise reading because both results are determined by the white noise and the location of the 1/f corner frequency.

Current noise is measured by the circuit and formula shown in Figure 28. The noise of the source resistors is subtracted.

LT1013, LT1013A, LT1013D DUAL PRECISION OPERATIONAL AMPLIFIERS

SLOS018H – MAY 1988 – REVISED NOVEMBER 2004

APPLICATION INFORMATION

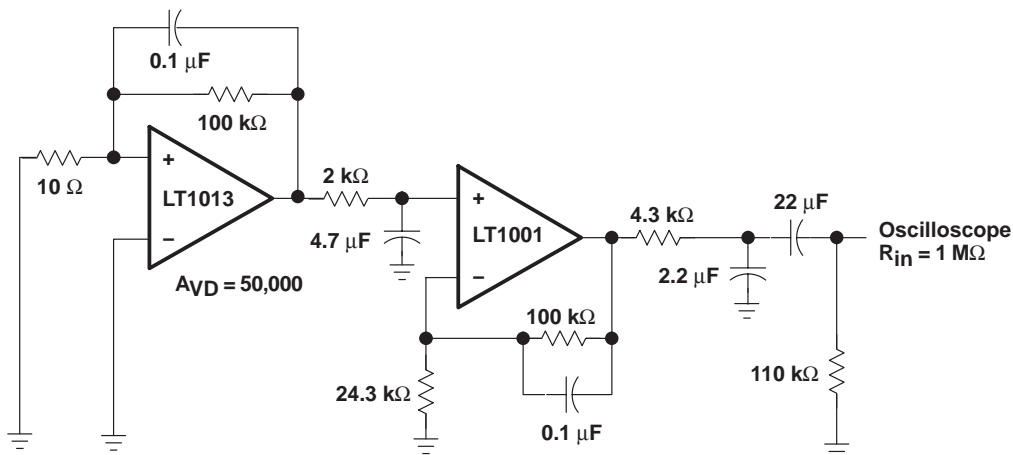

NOTE A: All capacitor values are for nonpolarized capacitors only.

Figure 27. 0.1-Hz to 10-Hz Peak-to-Peak Noise Test Circuit

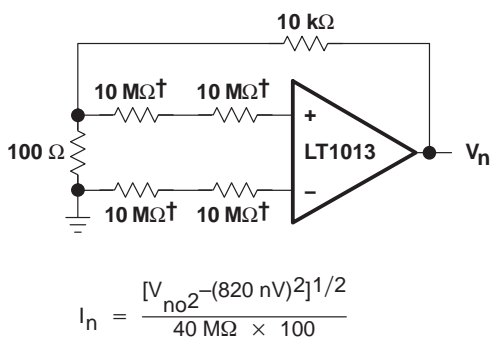

† Metal-film resistor

Figure 28. Noise-Current Test Circuit and Formula

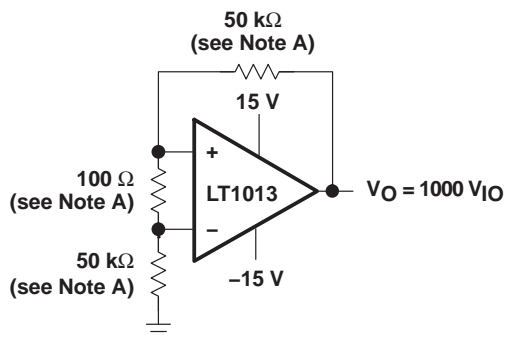

NOTE A: Resistors must have low thermoelectric potential.

Figure 29. Test Circuit for V_{IO} and $\alpha_{V_{IO}}$

APPLICATION INFORMATION

typical applications

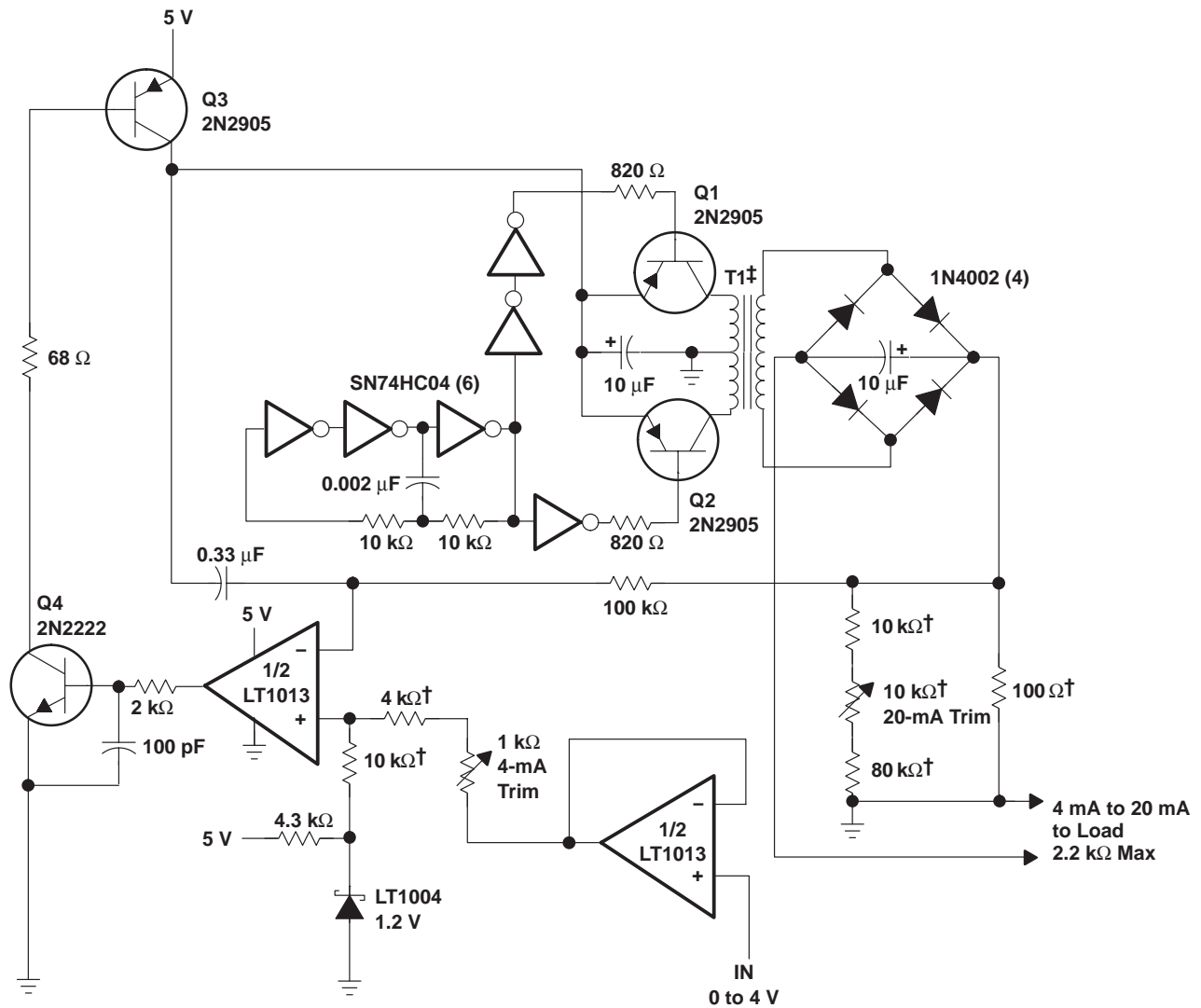

† 1% film resistor. Match 10-kΩ resistors to within 0.05%.

‡ T1 = PICO-31080

Figure 30. 5-V 4-mA to 20-mA Current-Loop Transmitter With 12-Bit Accuracy

LT1013, LT1013A, LT1013D DUAL PRECISION OPERATIONAL AMPLIFIERS

SLOS018H – MAY 1988 – REVISED NOVEMBER 2004

APPLICATION INFORMATION

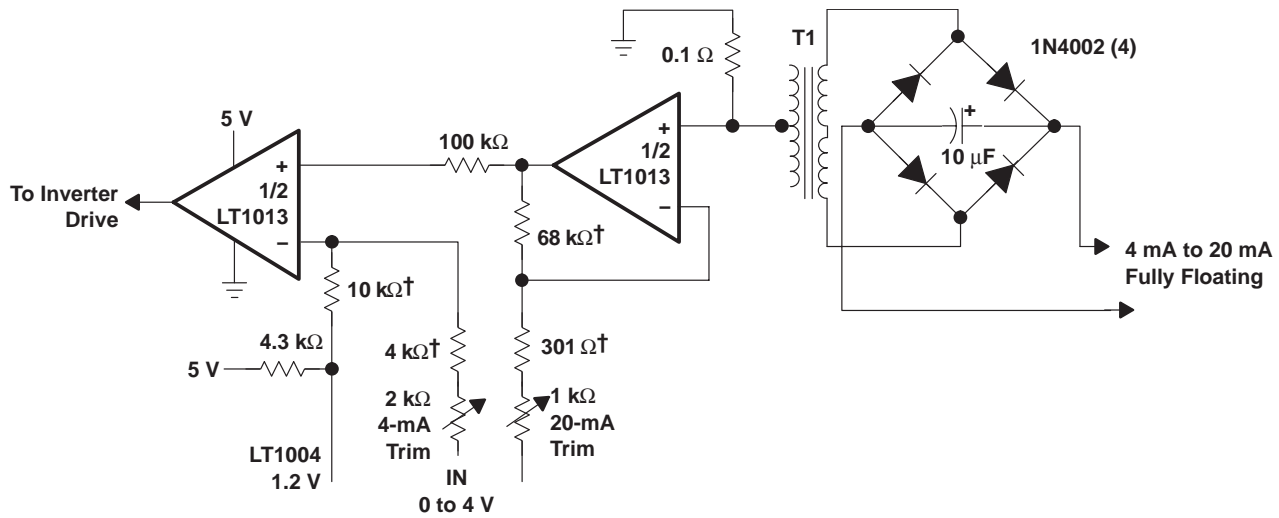

† 1% film resistor

Figure 31. Fully Floating Modification to 4-mA to 20-mA Current-Loop Transmitter With 8-Bit Accuracy

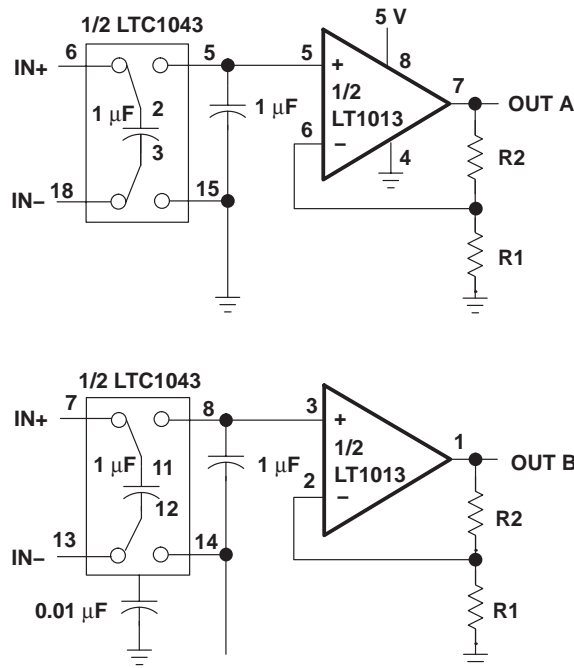

NOTE A: $V_{IO} = 150 \mu\text{V}$, $A_{VD} = (R1/R2) + 1$, $CMRR = 120 \text{ dB}$, $V_{ICR} = 0 \text{ to } 5 \text{ V}$

Figure 32. 5-V Single-Supply Dual Instrumentation Amplifier

APPLICATION INFORMATION

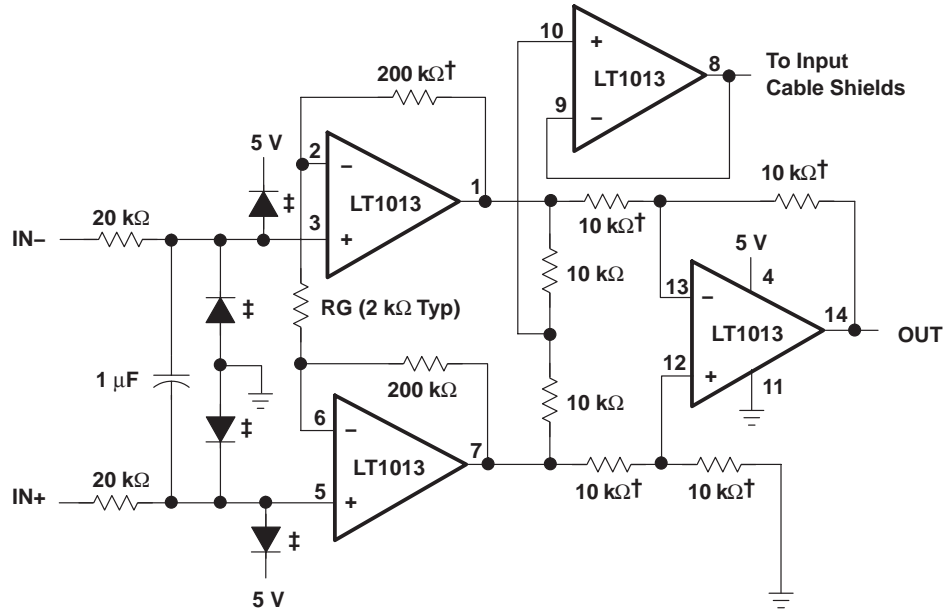

† 1% film resistor. Match 10-kΩ resistors to within 0.05%.

‡ For high source impedances, use 2N2222 diodes.

NOTE A: $A_{VD} = (400,000/RG) + 1$

Figure 33. 5-V Precision Instrumentation Amplifier

PACKAGING INFORMATION

Orderable Device	Status ⁽¹⁾	Package Type	Package Drawing	Pins	Package Qty	Eco Plan ⁽²⁾	Lead/ Ball Finish	MSL Peak Temp ⁽³⁾	Samples (Requires Login)
5962-88760012A	ACTIVE	LCCC	FK	20	1	TBD	Call TI	Call TI	
5962-8876001PA	ACTIVE	CDIP	JG	8	1	TBD	Call TI	Call TI	
5962-88760022A	ACTIVE	LCCC	FK	20	1	TBD	Call TI	Call TI	
5962-8876002PA	ACTIVE	CDIP	JG	8	1	TBD	Call TI	Call TI	
LT1013AMFKB	ACTIVE	LCCC	FK	20	1	TBD	POST-PLATE	N / A for Pkg Type	
LT1013AMJG	ACTIVE	CDIP	JG	8	1	TBD	A42	N / A for Pkg Type	
LT1013AMJGB	ACTIVE	CDIP	JG	8	1	TBD	A42	N / A for Pkg Type	
LT1013AMP	OBSOLETE	PDIP	P	8		TBD	Call TI	Call TI	
LT1013CD	ACTIVE	SOIC	D	8	75	Green (RoHS & no Sb/Br)	CU NIPDAU	Level-1-260C-UNLIM	
LT1013CDE4	ACTIVE	SOIC	D	8	75	Green (RoHS & no Sb/Br)	CU NIPDAU	Level-1-260C-UNLIM	
LT1013CDG4	ACTIVE	SOIC	D	8	75	Green (RoHS & no Sb/Br)	CU NIPDAU	Level-1-260C-UNLIM	
LT1013CDR	ACTIVE	SOIC	D	8	2500	Green (RoHS & no Sb/Br)	CU NIPDAU	Level-1-260C-UNLIM	
LT1013CDRE4	ACTIVE	SOIC	D	8	2500	Green (RoHS & no Sb/Br)	CU NIPDAU	Level-1-260C-UNLIM	
LT1013CDRG4	ACTIVE	SOIC	D	8	2500	Green (RoHS & no Sb/Br)	CU NIPDAU	Level-1-260C-UNLIM	
LT1013CP	ACTIVE	PDIP	P	8	50	Pb-Free (RoHS)	CU NIPDAU	N / A for Pkg Type	
LT1013CPE4	ACTIVE	PDIP	P	8	50	Pb-Free (RoHS)	CU NIPDAU	N / A for Pkg Type	
LT1013DD	ACTIVE	SOIC	D	8	75	Green (RoHS & no Sb/Br)	CU NIPDAU	Level-1-260C-UNLIM	
LT1013DDE4	ACTIVE	SOIC	D	8	75	Green (RoHS & no Sb/Br)	CU NIPDAU	Level-1-260C-UNLIM	
LT1013DDG4	ACTIVE	SOIC	D	8	75	Green (RoHS & no Sb/Br)	CU NIPDAU	Level-1-260C-UNLIM	
LT1013DDR	ACTIVE	SOIC	D	8	2500	Green (RoHS & no Sb/Br)	CU NIPDAU	Level-1-260C-UNLIM	
LT1013DDRE4	ACTIVE	SOIC	D	8	2500	Green (RoHS & no Sb/Br)	CU NIPDAU	Level-1-260C-UNLIM	

Orderable Device	Status ⁽¹⁾	Package Type	Package Drawing	Pins	Package Qty	Eco Plan ⁽²⁾	Lead/ Ball Finish	MSL Peak Temp ⁽³⁾	Samples (Requires Login)
LT1013DDRG4	ACTIVE	SOIC	D	8	2500	Green (RoHS & no Sb/Br)	CU NIPDAU	Level-1-260C-UNLIM	
LT1013DID	ACTIVE	SOIC	D	8	75	Green (RoHS & no Sb/Br)	CU NIPDAU	Level-1-260C-UNLIM	
LT1013DIDE4	ACTIVE	SOIC	D	8	75	Green (RoHS & no Sb/Br)	CU NIPDAU	Level-1-260C-UNLIM	
LT1013DIDG4	ACTIVE	SOIC	D	8	75	Green (RoHS & no Sb/Br)	CU NIPDAU	Level-1-260C-UNLIM	
LT1013DIDR	ACTIVE	SOIC	D	8	2500	Green (RoHS & no Sb/Br)	CU NIPDAU	Level-1-260C-UNLIM	
LT1013DIDRE4	ACTIVE	SOIC	D	8	2500	Green (RoHS & no Sb/Br)	CU NIPDAU	Level-1-260C-UNLIM	
LT1013DIDRG4	ACTIVE	SOIC	D	8	2500	Green (RoHS & no Sb/Br)	CU NIPDAU	Level-1-260C-UNLIM	
LT1013DIP	ACTIVE	PDIP	P	8	50	Pb-Free (RoHS)	CU NIPDAU	N / A for Pkg Type	
LT1013DIPE4	ACTIVE	PDIP	P	8	50	Pb-Free (RoHS)	CU NIPDAU	N / A for Pkg Type	
LT1013DMD	ACTIVE	SOIC	D	8	75	Green (RoHS & no Sb/Br)	CU NIPDAU	Level-1-260C-UNLIM	
LT1013DMDG4	ACTIVE	SOIC	D	8	75	Green (RoHS & no Sb/Br)	CU NIPDAU	Level-1-260C-UNLIM	
LT1013DP	ACTIVE	PDIP	P	8	50	Pb-Free (RoHS)	CU NIPDAU	N / A for Pkg Type	
LT1013DPE4	ACTIVE	PDIP	P	8	50	Pb-Free (RoHS)	CU NIPDAU	N / A for Pkg Type	
LT1013IP	OBSOLETE	PDIP	P	8		TBD	Call TI	Call TI	
LT1013MFKB	ACTIVE	LCCC	FK	20	1	TBD	POST-PLATE	N / A for Pkg Type	
LT1013MJG	ACTIVE	CDIP	JG	8	1	TBD	A42	N / A for Pkg Type	
LT1013MJGB	ACTIVE	CDIP	JG	8	1	TBD	A42	N / A for Pkg Type	
LT1013MP	OBSOLETE	PDIP	P	8		TBD	Call TI	Call TI	
LT1013Y	OBSOLETE	DIESALE	Y	0		TBD	Call TI	Call TI	

⁽¹⁾ The marketing status values are defined as follows:

ACTIVE: Product device recommended for new designs.

LIFEBUY: TI has announced that the device will be discontinued, and a lifetime-buy period is in effect.

NRND: Not recommended for new designs. Device is in production to support existing customers, but TI does not recommend using this part in a new design.

PREVIEW: Device has been announced but is not in production. Samples may or may not be available.

OBSOLETE: TI has discontinued the production of the device.

⁽²⁾ Eco Plan - The planned eco-friendly classification: Pb-Free (RoHS), Pb-Free (RoHS Exempt), or Green (RoHS & no Sb/Br) - please check <http://www.ti.com/productcontent> for the latest availability information and additional product content details.

TBD: The Pb-Free/Green conversion plan has not been defined.

Pb-Free (RoHS): TI's terms "Lead-Free" or "Pb-Free" mean semiconductor products that are compatible with the current RoHS requirements for all 6 substances, including the requirement that lead not exceed 0.1% by weight in homogeneous materials. Where designed to be soldered at high temperatures, TI Pb-Free products are suitable for use in specified lead-free processes.

Pb-Free (RoHS Exempt): This component has a RoHS exemption for either 1) lead-based flip-chip solder bumps used between the die and package, or 2) lead-based die adhesive used between the die and leadframe. The component is otherwise considered Pb-Free (RoHS compatible) as defined above.

Green (RoHS & no Sb/Br): TI defines "Green" to mean Pb-Free (RoHS compatible), and free of Bromine (Br) and Antimony (Sb) based flame retardants (Br or Sb do not exceed 0.1% by weight in homogeneous material)

⁽³⁾ MSL, Peak Temp. -- The Moisture Sensitivity Level rating according to the JEDEC industry standard classifications, and peak solder temperature.

Important Information and Disclaimer: The information provided on this page represents TI's knowledge and belief as of the date that it is provided. TI bases its knowledge and belief on information provided by third parties, and makes no representation or warranty as to the accuracy of such information. Efforts are underway to better integrate information from third parties. TI has taken and continues to take reasonable steps to provide representative and accurate information but may not have conducted destructive testing or chemical analysis on incoming materials and chemicals. TI and TI suppliers consider certain information to be proprietary, and thus CAS numbers and other limited information may not be available for release.

In no event shall TI's liability arising out of such information exceed the total purchase price of the TI part(s) at issue in this document sold by TI to Customer on an annual basis.

OTHER QUALIFIED VERSIONS OF LT1013, LT1013M :

- Catalog: [LT1013](#)
- Military: [LT1013M](#)

NOTE: Qualified Version Definitions:

- Catalog - TI's standard catalog product
- Military - QML certified for Military and Defense Applications

TAPE AND REEL INFORMATION



QUADRANT ASSIGNMENTS FOR PIN 1 ORIENTATION IN TAPE



*All dimensions are nominal

Device	Package Type	Package Drawing	Pins	SPQ	Reel Diameter (mm)	Reel Width W1 (mm)	A0 (mm)	B0 (mm)	K0 (mm)	P1 (mm)	W (mm)	Pin1 Quadrant
LT1013CDR	SOIC	D	8	2500	330.0	12.4	6.4	5.2	2.1	8.0	12.0	Q1
LT1013DDR	SOIC	D	8	2500	330.0	12.4	6.4	5.2	2.1	8.0	12.0	Q1
LT1013DIDR	SOIC	D	8	2500	330.0	12.4	6.4	5.2	2.1	8.0	12.0	Q1

TAPE AND REEL BOX DIMENSIONS



*All dimensions are nominal

Device	Package Type	Package Drawing	Pins	SPQ	Length (mm)	Width (mm)	Height (mm)
LT1013CDR	SOIC	D	8	2500	340.5	338.1	20.6
LT1013DDR	SOIC	D	8	2500	340.5	338.1	20.6
LT1013DIDR	SOIC	D	8	2500	340.5	338.1	20.6

JG (R-GDIP-T8)

CERAMIC DUAL-IN-LINE



- NOTES: A. All linear dimensions are in inches (millimeters).
 B. This drawing is subject to change without notice.
 C. This package can be hermetically sealed with a ceramic lid using glass frit.
 D. Index point is provided on cap for terminal identification.
 E. Falls within MIL STD 1835 GDIP1-T8

FK (S-CQCC-N**)

LEADLESS CERAMIC CHIP CARRIER

28 TERMINAL SHOWN



NO. OF TERMINALS **	A		B	
	MIN	MAX	MIN	MAX
20	0.342 (8,69)	0.358 (9,09)	0.307 (7,80)	0.358 (9,09)
28	0.442 (11,23)	0.458 (11,63)	0.406 (10,31)	0.458 (11,63)
44	0.640 (16,26)	0.660 (16,76)	0.495 (12,58)	0.560 (14,22)
52	0.740 (18,78)	0.761 (19,32)	0.495 (12,58)	0.560 (14,22)
68	0.938 (23,83)	0.962 (24,43)	0.850 (21,6)	0.858 (21,8)
84	1.141 (28,99)	1.165 (29,59)	1.047 (26,6)	1.063 (27,0)



4040140/D 01/11

- NOTES:
- All linear dimensions are in inches (millimeters).
 - This drawing is subject to change without notice.
 - This package can be hermetically sealed with a metal lid.
 - Falls within JEDEC MS-004

P (R-PDIP-T8)

PLASTIC DUAL-IN-LINE PACKAGE



- NOTES:
- A. All linear dimensions are in inches (millimeters).
 - B. This drawing is subject to change without notice.
 - C. Falls within JEDEC MS-001 variation BA.

D (R-PDSO-G8)

PLASTIC SMALL OUTLINE



NOTES: A. All linear dimensions are in inches (millimeters).
 B. This drawing is subject to change without notice.
 C. Body length does not include mold flash, protrusions, or gate burrs. Mold flash, protrusions, or gate burrs shall not exceed 0.006 (0,15) each side.
 D. Body width does not include interlead flash. Interlead flash shall not exceed 0.017 (0,43) each side.
 E. Reference JEDEC MS-012 variation AA.

D (R-PDSO-G8)

PLASTIC SMALL OUTLINE



4211283-2/E 08/12

- NOTES:
- All linear dimensions are in millimeters.
 - This drawing is subject to change without notice.
 - Publication IPC-7351 is recommended for alternate designs.
 - Laser cutting apertures with trapezoidal walls and also rounding corners will offer better paste release. Customers should contact their board assembly site for stencil design recommendations. Refer to IPC-7525 for other stencil recommendations.
 - Customers should contact their board fabrication site for solder mask tolerances between and around signal pads.

IMPORTANT NOTICE

Texas Instruments Incorporated and its subsidiaries (TI) reserve the right to make corrections, enhancements, improvements and other changes to its semiconductor products and services per JESD46, latest issue, and to discontinue any product or service per JESD48, latest issue. Buyers should obtain the latest relevant information before placing orders and should verify that such information is current and complete. All semiconductor products (also referred to herein as "components") are sold subject to TI's terms and conditions of sale supplied at the time of order acknowledgment.

TI warrants performance of its components to the specifications applicable at the time of sale, in accordance with the warranty in TI's terms and conditions of sale of semiconductor products. Testing and other quality control techniques are used to the extent TI deems necessary to support this warranty. Except where mandated by applicable law, testing of all parameters of each component is not necessarily performed.

TI assumes no liability for applications assistance or the design of Buyers' products. Buyers are responsible for their products and applications using TI components. To minimize the risks associated with Buyers' products and applications, Buyers should provide adequate design and operating safeguards.

TI does not warrant or represent that any license, either express or implied, is granted under any patent right, copyright, mask work right, or other intellectual property right relating to any combination, machine, or process in which TI components or services are used. Information published by TI regarding third-party products or services does not constitute a license to use such products or services or a warranty or endorsement thereof. Use of such information may require a license from a third party under the patents or other intellectual property of the third party, or a license from TI under the patents or other intellectual property of TI.

Reproduction of significant portions of TI information in TI data books or data sheets is permissible only if reproduction is without alteration and is accompanied by all associated warranties, conditions, limitations, and notices. TI is not responsible or liable for such altered documentation. Information of third parties may be subject to additional restrictions.

Resale of TI components or services with statements different from or beyond the parameters stated by TI for that component or service voids all express and any implied warranties for the associated TI component or service and is an unfair and deceptive business practice. TI is not responsible or liable for any such statements.

Buyer acknowledges and agrees that it is solely responsible for compliance with all legal, regulatory and safety-related requirements concerning its products, and any use of TI components in its applications, notwithstanding any applications-related information or support that may be provided by TI. Buyer represents and agrees that it has all the necessary expertise to create and implement safeguards which anticipate dangerous consequences of failures, monitor failures and their consequences, lessen the likelihood of failures that might cause harm and take appropriate remedial actions. Buyer will fully indemnify TI and its representatives against any damages arising out of the use of any TI components in safety-critical applications.

In some cases, TI components may be promoted specifically to facilitate safety-related applications. With such components, TI's goal is to help enable customers to design and create their own end-product solutions that meet applicable functional safety standards and requirements. Nonetheless, such components are subject to these terms.

No TI components are authorized for use in FDA Class III (or similar life-critical medical equipment) unless authorized officers of the parties have executed a special agreement specifically governing such use.

Only those TI components which TI has specifically designated as military grade or "enhanced plastic" are designed and intended for use in military/aerospace applications or environments. Buyer acknowledges and agrees that any military or aerospace use of TI components which have **not** been so designated is solely at the Buyer's risk, and that Buyer is solely responsible for compliance with all legal and regulatory requirements in connection with such use.

TI has specifically designated certain components which meet ISO/TS16949 requirements, mainly for automotive use. Components which have not been so designated are neither designed nor intended for automotive use; and TI will not be responsible for any failure of such components to meet such requirements.

Products

Audio	www.ti.com/audio
Amplifiers	amplifier.ti.com
Data Converters	dataconverter.ti.com
DLP® Products	www.dlp.com
DSP	dsp.ti.com
Clocks and Timers	www.ti.com/clocks
Interface	interface.ti.com
Logic	logic.ti.com
Power Mgmt	power.ti.com
Microcontrollers	microcontroller.ti.com
RFID	www.ti-rfid.com
OMAP Applications Processors	www.ti.com/omap
Wireless Connectivity	www.ti.com/wirelessconnectivity

Applications

Automotive and Transportation	www.ti.com/automotive
Communications and Telecom	www.ti.com/communications
Computers and Peripherals	www.ti.com/computers
Consumer Electronics	www.ti.com/consumer-apps
Energy and Lighting	www.ti.com/energy
Industrial	www.ti.com/industrial
Medical	www.ti.com/medical
Security	www.ti.com/security
Space, Avionics and Defense	www.ti.com/space-avionics-defense
Video and Imaging	www.ti.com/video

TI E2E Community

e2e.ti.com