

MITSUBISHI IGBT MODULES
CM75E3U-24H
 HIGH POWER SWITCHING USE
 INSULATED TYPE

CM75E3U-24H



- Ic 75A
- VCES 1200V
- Insulated Type
- 1-element in a pack

APPLICATION

Brake

OUTLINE DRAWING & CIRCUIT DIAGRAM

Dimensions in mm

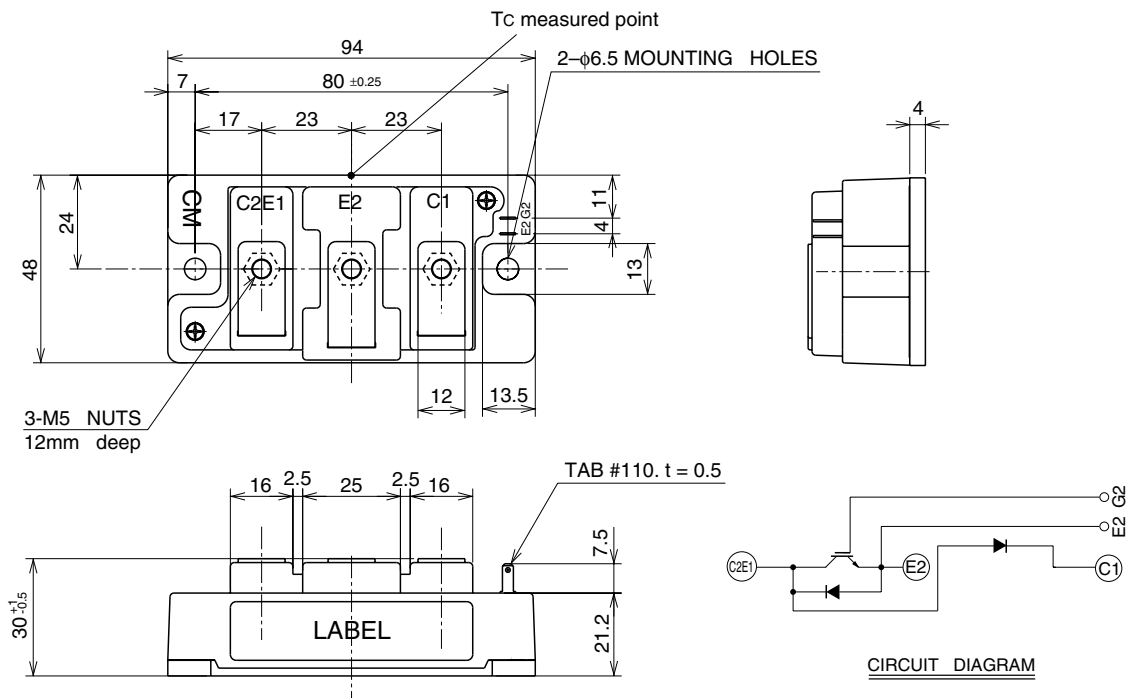

CM75E3U-24H

**HIGH POWER SWITCHING USE
INSULATED TYPE**

MAXIMUM RATINGS (T_j = 25°C, unless otherwise specified)

Symbol	Item	Conditions	Ratings	Unit
V _{CE} S	Collector-emitter voltage	V _{GE} = 0V	1200	V
V _{GE} S	Gate-emitter voltage	V _{CE} = 0V	±20	V
I _C	Collector current	T _C = 25°C	75	A
I _{CM}		Pulse (Note 1)	150	A
I _E (Note 2)	Emitter current	T _C = 25°C	75	A
I _{EM} (Note 2)		Pulse (Note 1)	150	A
P _C (Note 3)	Maximum collector dissipation	T _C = 25°C	600	W
T _j	Junction temperature	—	-40 ~ +150	°C
T _{stg}	Storage temperature	—	-40 ~ +125	°C
V _{iso}	Isolation voltage	Charged part to base plate, f = 60Hz, AC 1 minute	2500	V _{rms}
—	Mounting torque	Main terminals M5 screw	2.5 ~ 3.5	N·m
		Mounting M6 screw	3.5 ~ 4.5	N·m
—	Weight	Typical value	310	g

ELECTRICAL CHARACTERISTICS (T_j = 25°C, unless otherwise specified)

Symbol	Item	Test Conditions	Limits			Unit
			Min	Typ	Max	
I _{CE} S	Collector cutoff current	V _{CE} = V _{CE} S, V _{GE} = 0V	—	—	1	mA
V _{GE(th)}	Gate-emitter threshold voltage	I _C = 7.5mA, V _{CE} = 10V	4.5	6	7.5	V
I _{GE} S	Gate-leakage current	±V _{GE} = V _{GE} S, V _{CE} = 0V	—	—	0.5	μA
V _{CE(sat)}	Collector-emitter saturation voltage	I _C = 75A, V _{GE} = 15V (Note 4)	—	2.9	3.7	V
		T _j = 125°C	—	2.85	—	
C _{ies}	Input capacitance	V _{CE} = 10V V _{GE} = 0V	—	—	11	nF
C _{oes}	Output capacitance		—	—	3.7	nF
C _{res}	Reverse transfer capacitance		—	—	2.2	nF
Q _G	Total gate charge	V _{CC} = 600V, I _C = 75A, V _{GE} = 15V	—	280	—	nC
t _{d(on)}	Turn-on delay time	V _{CC} = 600V, I _C = 75A	—	—	100	ns
t _r	Turn-on rise time	V _{GE} = ±15V	—	—	200	ns
t _{d(off)}	Turn-off delay time	R _G = 4.2Ω	—	—	250	ns
t _f	Turn-off fall time	Resistive load	—	—	350	ns
V _{EC} (Note 2)	Emitter-collector voltage	I _E = 75A, V _{GE} = 0V	—	—	3.2	V
t _{rr} (Note 2)	Reverse recovery time	I _E = 75A	—	—	300	ns
Q _{rr} (Note 2)	Reverse recovery charge	die / dt = -150A / μs	—	0.41	—	μC
R _{th(j-c)Q}	Thermal resistance (Note 5)	Junction to case, IGBT part	—	—	0.21	K/W
R _{th(j-c)R}		Junction to case, FWDi part	—	—	0.47	K/W
V _{FM}	Forward voltage	I _F = 75A, Clamp diode part	—	—	3.2	V
t _{rr}	Reverse recovery time	I _F = 75A	—	—	300	ns
Q _{rr}	Reverse recovery charge	dif / dt = -150A / μs, Clamp diode part	—	0.41	—	μC
R _{th(j-c)}	Thermal resistance (Note 5)	Junction to case, Clamp diode part	—	—	0.47	K/W
R _{th(c-f)}	Contact thermal resistance	Case to heat sink, conductive grease applied (Per 1/2 module) (Note 6)	—	0.07	—	K/W

Note 1. Pulse width and repetition rate should be such that the device junction temperature (T_j) does not exceed T_{jmax} rating.

2. I_E, V_{EC}, t_{rr}, Q_{rr} & die/dt represent characteristics of the anti-parallel, emitter-collector free-wheel diode.

3. Junction temperature (T_j) should not increase beyond 150°C.

4. Pulse width and repetition rate should be such as to cause negligible temperature rise.

5. Case temperature (T_C) measured point is shown in page OUTLINE DRAWING.

6. Typical value is measured by using thermally conductive grease of λ = 0.9[W/(m · K)].

CM75E3U-24H

HIGH POWER SWITCHING USE
INSULATED TYPE

PERFORMANCE CURVES

OUTPUT CHARACTERISTICS (TYPICAL)

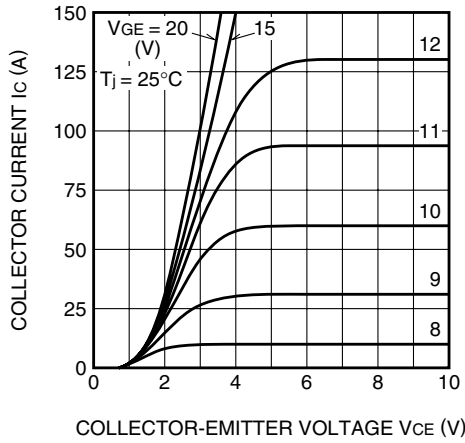

TRANSFER CHARACTERISTICS (TYPICAL)

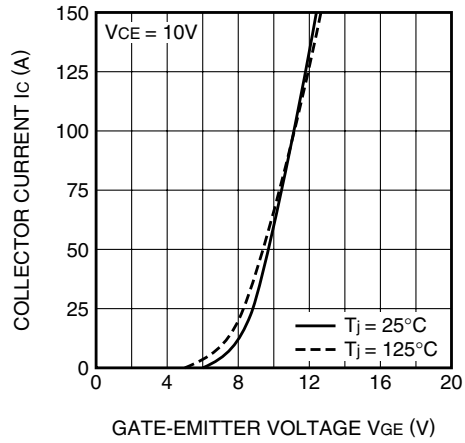

COLLECTOR-EMITTER SATURATION VOLTAGE CHARACTERISTICS (TYPICAL)

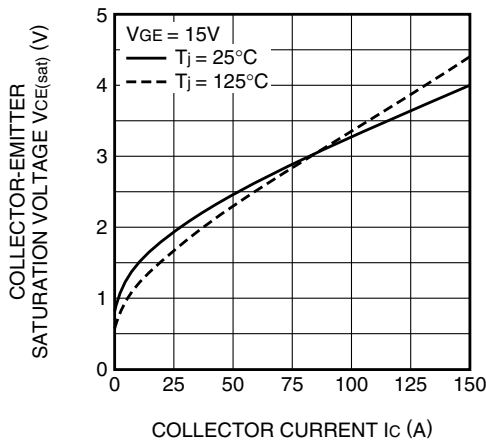

COLLECTOR-EMITTER SATURATION VOLTAGE CHARACTERISTICS (TYPICAL)

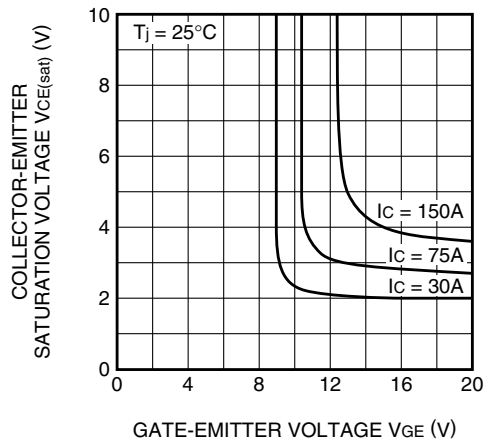

FREE-WHEEL DIODE FORWARD CHARACTERISTICS (TYPICAL)

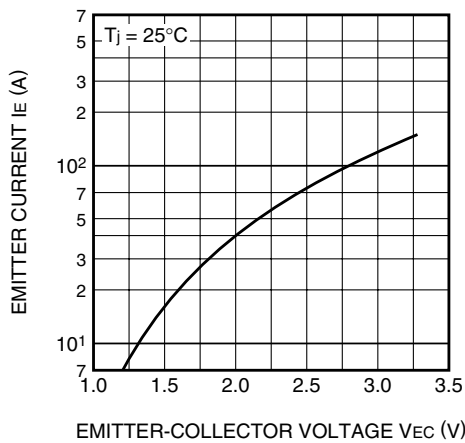

CAPACITANCE CHARACTERISTICS (TYPICAL)

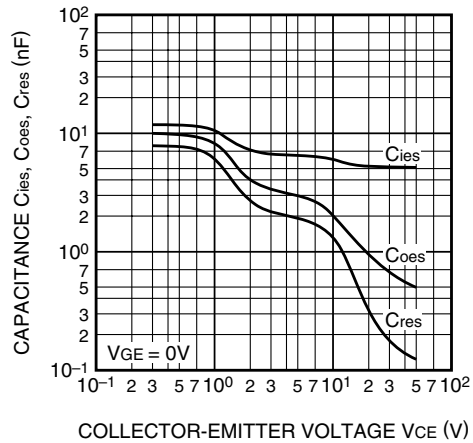

CM75E3U-24H

HIGH POWER SWITCHING USE
INSULATED TYPE

**HALF-BRIDGE
SWITCHING TIME CHARACTERISTICS
(TYPICAL)**

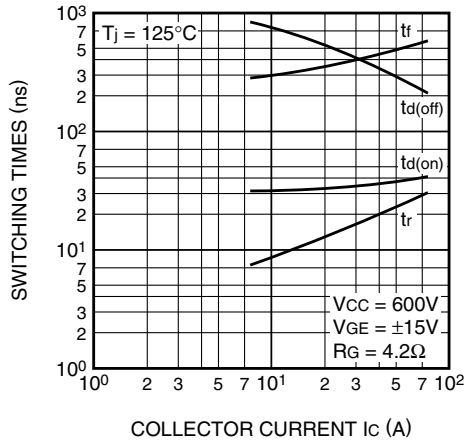

**REVERSE RECOVERY CHARACTERISTICS
OF FREE-WHEEL DIODE
(TYPICAL)**

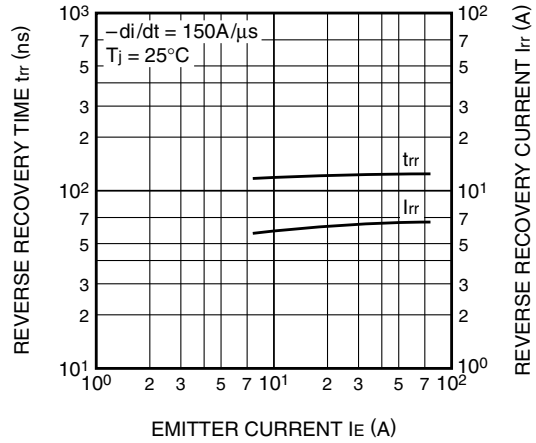

**TRANSIENT THERMAL
IMPEDANCE CHARACTERISTICS
(IGBT part)**

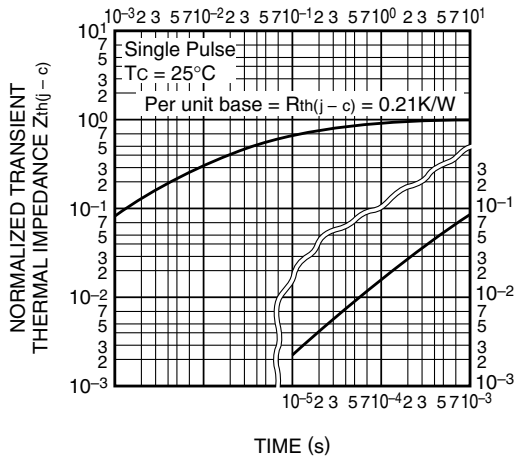

**TRANSIENT THERMAL
IMPEDANCE CHARACTERISTICS
(FWDi part)**

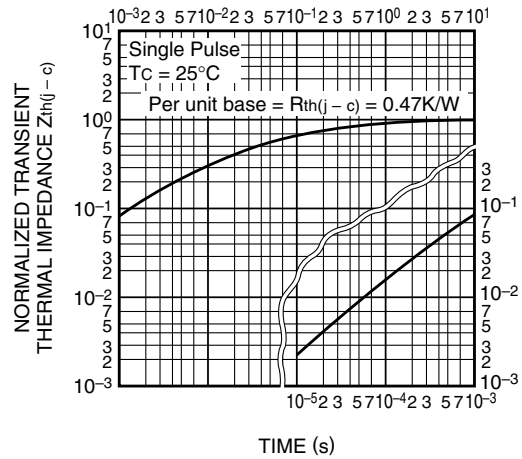

**GATE CHARGE CHARACTERISTICS
(TYPICAL)**

