

## DIGITAL FIBER SENSOR FS-V30/31(P)/31C(P)/31M/32(P)/32C(P) Instruction Manual

### Warning

- This product is used to detect targets. Do not apply the product to safety circuits for human protection.
- This product is not of explosion-proof construction. Do not use the products in places with flammable gas, liquid, or dust.
- This product is a sensor of DC power supply type. Do not apply AC power. The product may explode or burn if an AC voltage is applied.

### Part Names

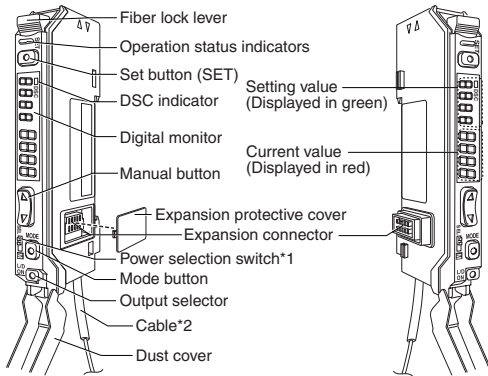

\*1 When set to "M", the power mode is fixed to Mega Turbo.

\*2 FS-V30 does not have the cable. M8 connector for FS-V31C(P)/32C(P)

### I/O Circuit

#### ■ FS-V31/32/31M

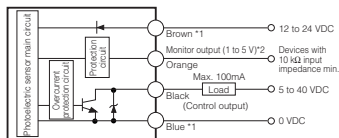

\*1 FS-V31/31M only

\*2 FS-31M only

#### ■ FS-V31P/32P

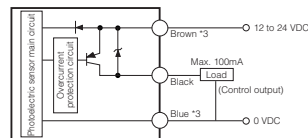

\*3 FS-V31P only

#### ■ FS-V31C/32C

Output Circuit Diagram

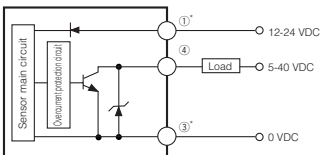

Pin assignment



Input Circuit Diagram

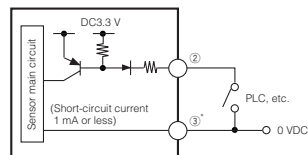

\* FS-V31C only

#### ■ FS-V31CP/32CP

Output Circuit Diagram

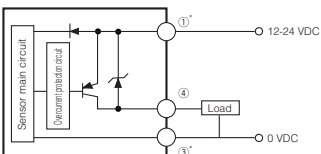

Pin assignment



Input Circuit Diagram

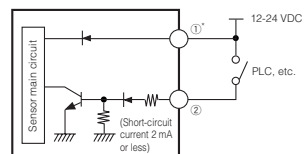

\* FS-V31CP only

#### ■ Socket Cable (Sold Separately)

For FS-V31C(P)/32C(P)

OP-73864 (cable length: 2 m)

OP-73865 (cable length: 10 m)

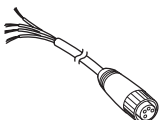

Pin and wire color table

Connected pin No.	Core wire cover color
①	Brown
②	White
③	Blue
④	Black

### Mounting Unit

#### ■ Mounting on a DIN Rail

1 Align the claw at the bottom of the main body with the DIN rail. While pushing the main body in the direction of the arrow 1, slant it in the direction of the arrow 2.

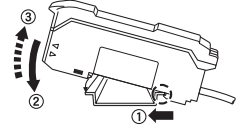

2 To dismount the sensor, raise the main body in the direction of the arrow 3 while pushing the main body in the direction of the arrow 1.

#### ■ Installation on a Wall (Main Unit Only)

Attach the unit to the optional mounting bracket (OP-73880), mount them together, and secure them with two M3 screws as shown in the illustration.

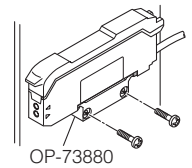

### Connecting Multiple Amplifiers

Up to 16 sub units can be connected to one main unit.

1 Remove the protection cover on the side of the main unit.

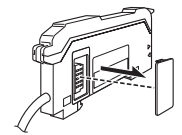

2 Install the amplifier one by one on the DIN rail.

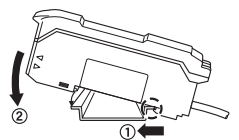

3 Engage the two claws of the child unit with the recesses on the main unit side until you hear a click sound.

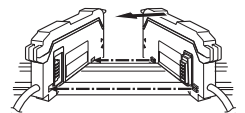

4 Attach the end units (option: OP-26751) to the both ends of the connected amplifiers in the same way as in step (2).

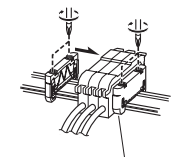

5 Sandwich the amplifiers between the end units. Tighten the screws at the top (two screws x two units) with a Phillips screwdriver to fix the end units.

OP-26751 (a set of two)

### Connecting Fiber Unit

1 Open the dust cover in the direction shown by arrow 1.

2 Move down the fiber lock lever in the direction shown by arrow 2.

3 Insert a fiber unit into the fiber insertion holes to a length of the fiber insertion sign (i.e., approximately 14 mm).

4 Move down the fiber lock lever in the direction shown by arrow 4.

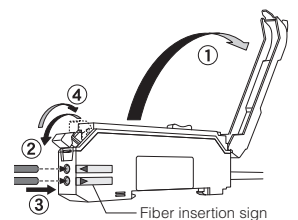

#### Note

If a thin fiber unit is used, an adapter provided with the thin fiber unit will be required. Unless the right adapter is connected, the thin fiber unit will not detect targets correctly. (The adapter is supplied with the fiber unit.)

Cable outer dia.	Adapter	Appearance
ø1.3	Adapter A (OP-26500)	
ø1.0	Adapter B (OP-26501)	

• To connect the coaxial reflective type fiber unit to the amplifier, connect the single-core fiber to the transmitter side, and connect the multiple-core fiber to the receiver side.

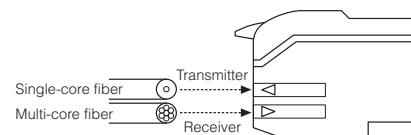

## Making Sensitivity Settings

### Two-point Calibration

In this mode, the PV used will be the mean value of two sensing values obtained with and without a workpiece.

- 1 Press the SET button without any workpiece placed in front of the fiber unit.

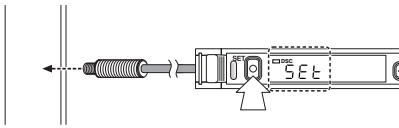

- 2 Place a workpiece placed in front of the fiber unit, and press the SET button.

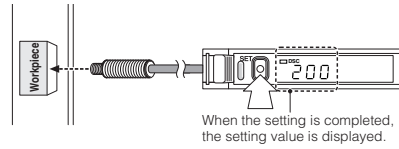

If the sensitivity difference does not have enough room, "----" flashes for about two seconds after the calibration is complete. The set value is stored in memory even in that case.

### Maximum Sensitivity Setting

Set the sensitivity without a workpiece in the case of the reflective type, and with a workpiece in the case of the through-beam or retro-reflective type.

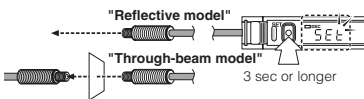

Press the SET button for three seconds in the state as shown in the above figure. (Release the button when SET flashes.)

When setting the sensitivity, set the value slightly higher than the received light intensity.

### Full Auto Calibration

In this mode, the PV will be set to the mean value of the maximum and minimum incident values obtained within a certain period. Use this mode to detect moving workpieces.

- 1 Press the set button for a minimum of three seconds while the target workpiece is passing the sensing area of the fiber unit.
  - While the SET button is pressed, the sensitivity of the sensor will be set according to the incident values.

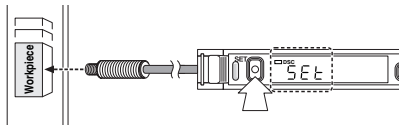

- After the setting is completed, the setting value is displayed on the digital monitor.

### Positioning Calibration

- 1 Press the SET button without any workpiece placed in front of the fiber unit.

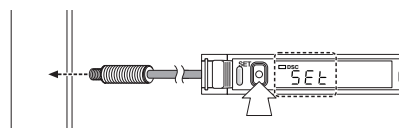

- 2 Place a workpiece on the position where you want to perform positioning.

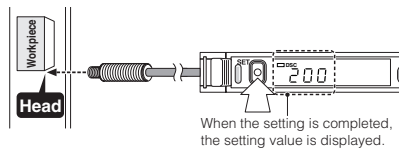

Press the SET button for 3 seconds or longer until the display flashes.

## Fine-adjusting Sensitivity

The setting value can be directly changed by pressing the manual button.

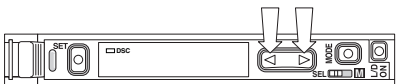

When extension display (page 5, No.8) is set for the number of digits to be displayed for the received light intensity

- 1 Press the manual button quickly once, and check that the setting value flashes.
- 2 While the setting value is flashing, change the setting value with the Manual button.

## Percentage (%) Calibration

This is a calibration method that can set the setting value by percentage with reference to the received light intensity at the time of sensitivity setting. For example, if the target value is set to -10P, the setting value is determined 10% lower than the received light intensity when the SET button is pressed.

- 1 When selecting the sensitivity setting method (page 4, No. 2), select the % calibration, and set the target value of calibration.
- 2 Taking the desired light intensity as a reference (normally without a workpiece), press the SET button.

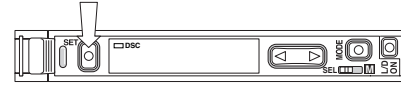

- \* While the % calibration is in use, other calibrations (sensitivity setting) cannot be used.
- \* With FS-V31C(P)/32C(P), by periodically performing external calibration from PLC or other devices, stable detection can be performed even with a small sensitivity difference.

## Output Selection

Either light-ON mode or dark-ON mode is selectable.

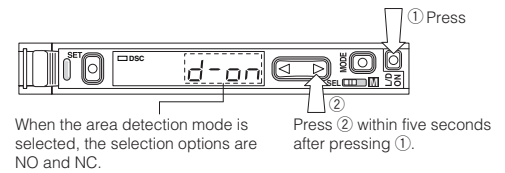

## Dynamic Sensitivity Correction (DSC) Function

DSC automatically corrects the setting value according to the changes in the received light intensity when there is no workpiece (output OFF). This function is effective when the light intensity difference is small when judging whether or not there is a workpiece.

At Detection mode selection (page 4, No.4), select "Dynamic sensitivity correction mode" beforehand.\*

How to set the sensitivity is the same as in the normal mode.

The DSC indicator illuminates when the DSC function is set.

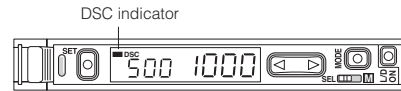

- \* When Light ON is selected, the upper limit of the correctable range is twice as much as the initial setting value.
- \* The value is stored in memory even after the power is turned off.
- \* The DSC indicator flashes when the light intensity during output OFF greatly fluctuates or the L/D ON selection is inappropriate. In such a case, check the setting again.

## Edge Detection Mode

This mode detects the change in the received light intensity during a given period of time.

	Rising edge detection	Detects the increase (rising edge) of the received light intensity
	Falling edge detection	Detects the decrease (falling edge) of the received light intensity

### Filter Setting

Basically, leave this setting as its initial value. If the passage interval of workpieces is too short for the unit to respond, strengthen the level and try again. The selectable filter level differs depending on the power modes.

Filter level	HSP*	FINE	TURBO	SUPER	ULTRA	MEGA
Default state	5	8	9	9	9	9
Setting range	1 to 5	4 to 8	5 to 9	6 to 9	8 to 9	9 only

\*HSP: HIGH SPEED

As the number becomes smaller, the filter becomes stronger, which makes the unit difficult to respond to gradual changes in light intensity.

### Making Sensitivity Settings

The sensitivity is set to maximum when the SET button is pressed quickly once. When the setting value is too low and the unit detects objects other than the workpiece, fine-adjust the setting value to a higher number.

### Operation When Switching Outputs

Setting	Operation
L-ON	Normally OFF. Turns ON only when the light intensity changes.
D-ON	Normally ON. Turns OFF only when the light intensity changes.

## Area Detection Mode

This mode is suited to detecting the received light intensity only of a certain range. To set this mode, select the area detection mode at Detection mode selection (page 4, No.4).

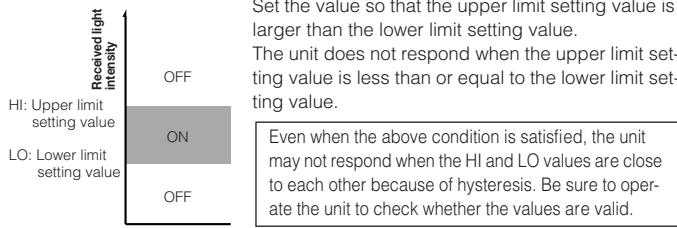

### How to switch the upper limit setting value (HI) and the lower limit setting value (LO)

When the ◀▶ button is pressed, "HI" or "LO" and the setting value alternately flash. When the MODE button is pressed while the display alternately flashes, the "HI" or "LO" display changes. How to configure the sensitivity setting is the same as when in the normal detection mode.

## Setting the Display Scaling

This is the function to adjust the current received light intensity to the scaling target value.

1 When selecting a display value correction function (page 5, No. 6), select the display scaling function, and set the target value.

2 During the normal display, press the SET button while pressing the MODE button. (Scaling is performed for the current light intensity at this time.)

The reference light intensity can be set in the following range in reference with the currently received light intensity:

Power mode	Minimum value	Maximum value
HIGH SPEED/FINE/TURBO	Approx. 1/20 times	Approx. 16 times
SUPER	Approx. 1/40 times	Approx. 8 times
ULTRA	Approx. 1/160 times	Approx. 2 times
MEGA	Approx. 1/320 times	Approx. 1 time

If the value exceeds the range, **Err** is displayed and scaling is performed up to the possible range.

- No value can be set when the Edge detection mode is selected.
- The value is stored in memory even after the power is turned off.
- The value is not reflected to the analog output of the FS-V31M.
- When using FS-V31C(P)/32C(P), external inputs can be used.

## Zero-shift Function

The Zero-shift function is used to forcibly set the current light intensity to zero.

1 At Display value correction function selection (page 5, No.6), select "Zero-shift function".

2 When the SET button is pressed while the MODE button is pressed, the current light intensity is forcibly set to zero.

- This function cannot be used when the Dynamic sensitivity correction (DSC) or Edge detection mode is selected.
- The value is stored in memory even after the power is turned off.
- The value is not reflected to the analog output of the FS-V31M.
- When using FS-V31C(P)/32C(P), external inputs can be used.

## External Input [Function only for FS-V31C(P)/V32C(P)]

1 Signals can be input externally by selecting an external input function (page 4, No. 4-C).

2 The signal can be accepted by short-circuiting the pin (2) for 2 ms or more as shown below for each model (20 ms for OFF).

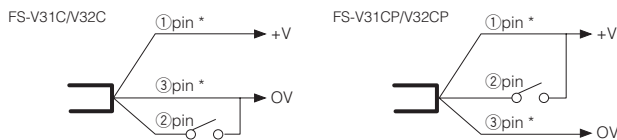

- \* For FS-V31C/31CP only.
- Setting using an external input is up to 1 million times.
- No inputs are accepted while setting each mode.

When external calibration is selected, the operation is the same as with the SET button.

### Special Function

By performing the following operation, both sensitivity setting and scaling can be performed using external input. Select external calibration (page 4, No. 4-C) and display scaling. The following is the example when using the % calibration.

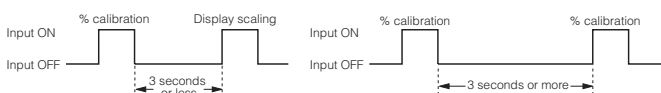

## Display Selection

The factory default value is "1" only. Other items can be displayed only after being selected at Display customization selection (page 5, No.8).

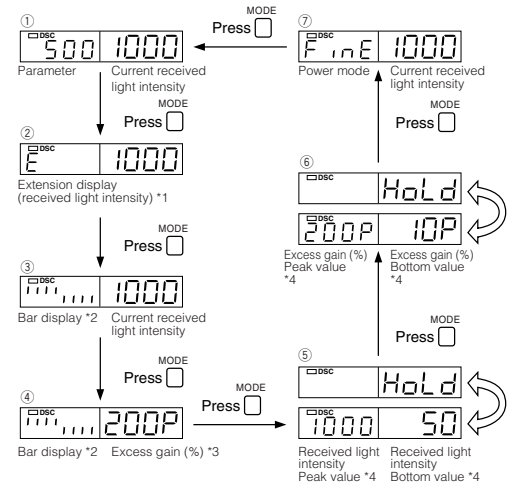

\*1 When ULTRA/MEGA mode is selected, the current received light intensity can be displayed up to 5 digits.

The setting value flashes when the ◀▶ button is pressed once.

The setting can be changed by pressing the ◀▶ button while flashing.

\*2 The excess gain is displayed in a 5% increment from 85 to 115%.

\*3 The current light intensity for the setting value is displayed in percentage.

\*4 Holds and displays the peak value and the bottom value.

### How to reset the peak and bottom values (with the 5/6 display)

While pressing the MODE button, press the SET button for 3 seconds or longer to reset the peak and bottom values. Turning the power off also resets the values.

With FS-V31C(P)/32C(P), the value can be reset externally by selecting Reset at External input function selection (page 4, No.4-C).

### User-friendly Functions (Direct Access Menu)

The hold display (5/6) can be set in detail by pressing the ▶ button for 2 seconds or longer.

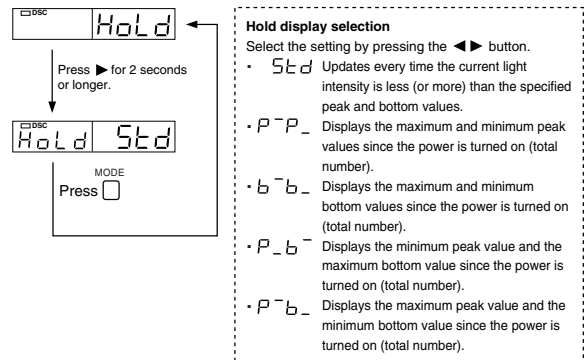

The power mode and attenuation function for the power mode display (3) can be set by pressing the ▶ button for 2 seconds or longer.

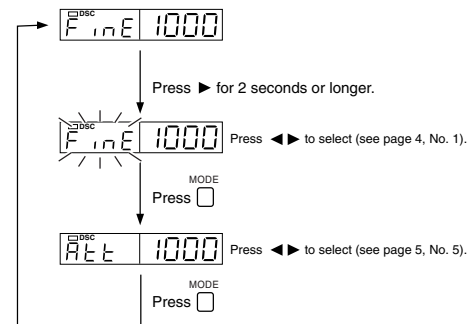

## Key Lock Function

The key lock function disables the operation of all keys.

1 While pressing the MODE button, press the ◀ (▶) button for at least three seconds.

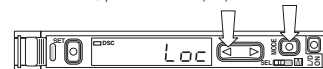

The same steps can be taken to deactivate key lock.

For more information on the key lock levels and the PIN number key lock function, refer to page 6.

## Operation Configuration

Normally, this unit can be used in the basic settings.  
Set other functions as necessary.

Pressing  $\text{MODE}$  for 3 seconds or longer displays the basic menu.

Select a function with the  $\leftarrow$   $\rightarrow$  button, and press  $\text{MODE}$  to confirm.

The setting for each item is confirmed when selecting END and pressing  $\text{MODE}$ .

- |                        |  |
|------------------------|--|
| Basic setting menu     | 1. Power mode selection                        |
| Detection setting menu | 2. Sensitivity setting method selection        |
| Display setting menu   | 3. Timer mode selection                        |
| System setting menu    | 4. Detection mode selection                    |
|                        | 4-C. External input function selection         |
|                        | 5. Light emission power selection              |
|                        | 6. Display value correction function selection |
|                        | 7. Display reverse selection                   |
|                        | 8. Display customization selection             |
|                        | 9. APC function setting                        |
|                        | 10. Power save mode setting                    |
|                        | 11. Key lock level setting                     |
|                        | 12. Interference prevention function setting   |

## Basic Setting Menu

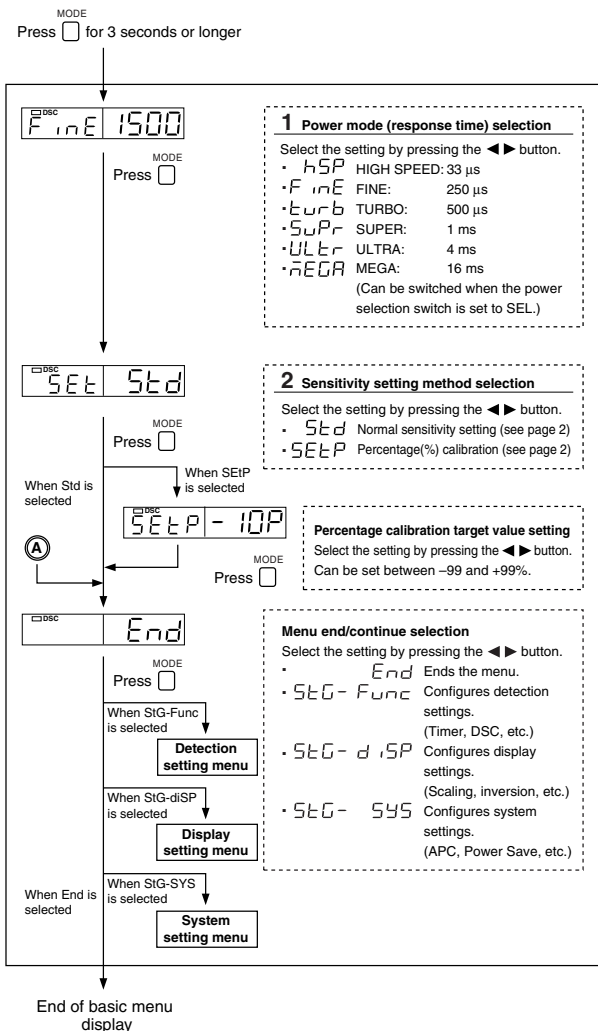

## Detection Setting Menu

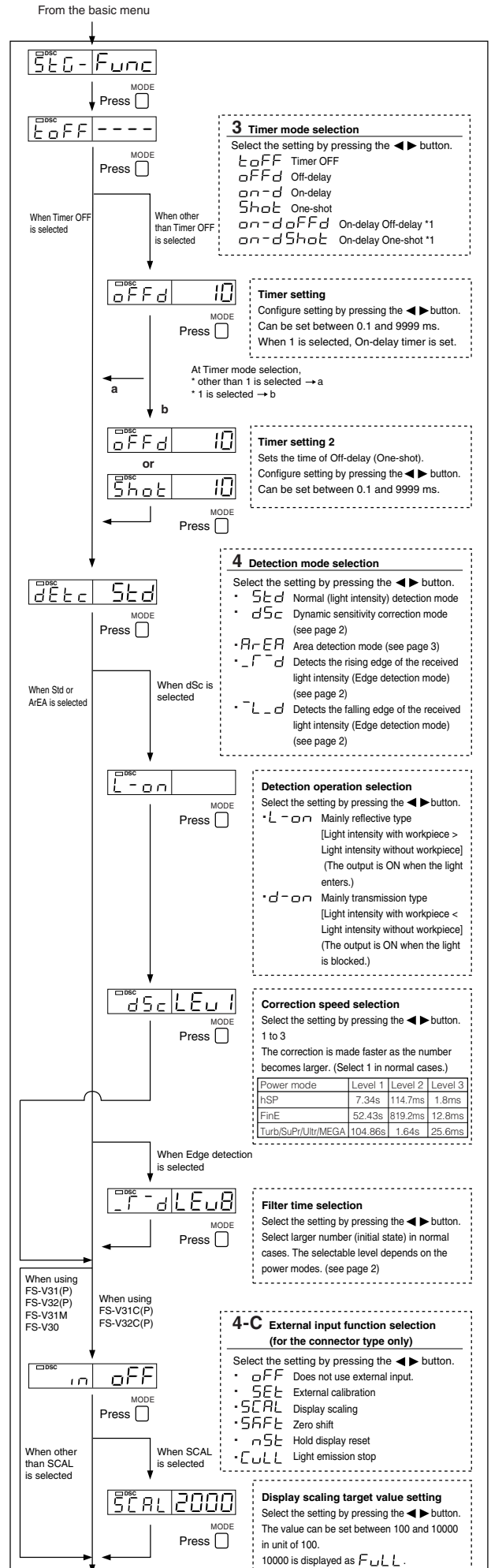

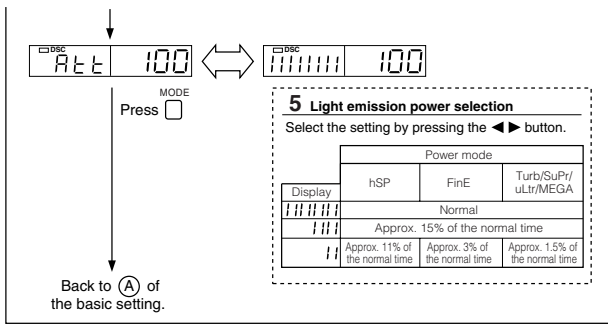

## Display Setting Menu

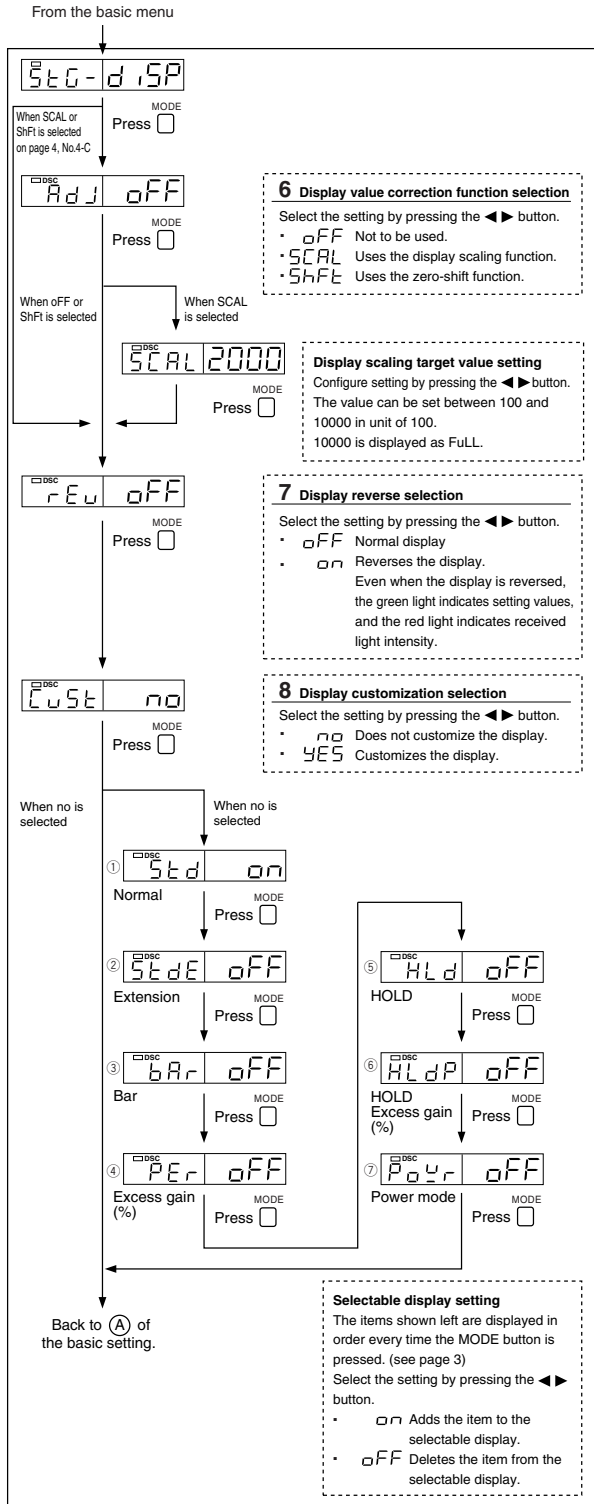

## System Setting Menu

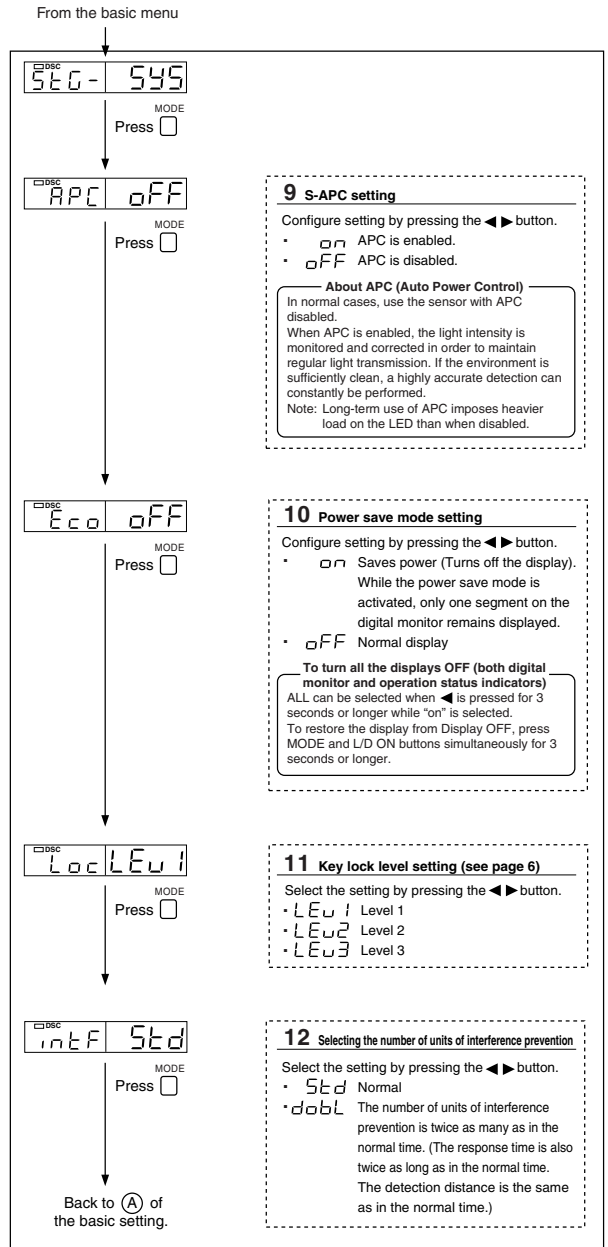

## Initializing, Saving and Loading the Settings

### ■ Initializing the settings

- 1 While pressing  $\frac{L/D}{ON}$ , press  $\frac{SET}{}$  for 5 seconds or longer.
- 2 Select "rSt" with the ◀▶ button, and press  $\frac{MODE}{}$ .
- 3 Select "init" with the ◀▶ button, and press  $\frac{MODE}{}$  to initialize.

#### Default setting

Power mode: FINE  
Detection mode: Normal  
Setting value: 50  
Output selection: L ON

### ■ Saving the settings

- 1 While pressing  $\frac{L/D}{ON}$ , press  $\frac{SET}{}$  for 5 seconds or longer.
- 2 Select "SRvE" with the ◀▶ button, and press  $\frac{MODE}{}$ .
- 3 Select "YES" with the ◀▶ button, and press  $\frac{MODE}{}$  to save.

### ■ Loading the setting

- 1 While pressing  $\frac{L/D}{ON}$ , press  $\frac{SET}{}$  for 5 seconds or longer.
- 2 Select "rSt" with the ◀▶ button, and press  $\frac{MODE}{}$ .
- 3 Select "LUsE" with the ◀▶ button, and press  $\frac{MODE}{}$  to load.

#### Reference

When setting each mode, the display returns normal by pressing the button for 3 seconds or longer.

## Key Lock Level Details

By selecting the key lock (page 5, No.11) level (1-3), key operations can be disabled or changed.

(The default value is level 1.)

Basic Operations	Button	Level			Advanced Operations	Button	Level		
		1	2	3			1	2	3
Sensitivity settings (p.2)	SET	×	○	○	Initialization (p.3)	L/D ON + press and hold SET	×	×	×
Sensitivity fine-adjustment (p.2)	◀▶	△	○	○	Display scaling (p.3)	MODE + quickly press SET	×	○	○
Power selection (p.1)	Power selection switch	×	×	×	Zero shift (p.3)	MODE + quickly press SET	×	○	○
Output selection (p.2)	L/D ON	×	×	×	Direct access menu (p.3)	Press and hold	×	×	△
Menu selection (p.4)	Press and hold MODE	×	×	△	Display OFF/ON (p.5, No.10)	L/D ON + press and hold MODE	○	○	○

○: Normal operation is possible. ×: Operation is not possible.  
△: The settings can be checked but cannot be changed.

## PIN Number Key Lock Function

The unit can be locked using a PIN number to ensure securer locking effect.

**1** While pressing the MODE button, press the ◀ (▶) button 10 times.

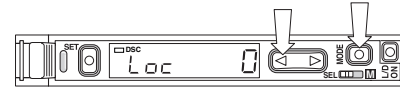

**2** Select a PIN number between 0 and 9999 using the button.

**3** Press the MODE button to activate key lock.

Follow the same step to disable the key lock. Use the same PIN number used for locking.

### Note

Write down the PIN number in case it is forgotten.

The key lock cannot be disabled unless the correct PIN number is used.

## Hints On Correct Use

- Do not wire the amplifier line along with power lines or high-tension lines, otherwise the sensor may malfunction or receive damage due to noise.
- When using a commercially available switching regulator, ground the frame ground terminal and ground terminal.
- Do not use the FS series outdoors, or in a place where extraneous light can enter the light receiving surface directly.
- Due to the individual dispersion of characteristics and the difference in fiber unit model, the maximum sensing distance or displayed value of all the units are not the same.
- If the sensor is used in S-APC mode for a long time, the LED indicators will be imposed with a heavy load. In that case, the sensor will be automatically set to ACC mode where the current consumption of the sensor for light emission will be constant, and "END APC" will be displayed. The sensor can be continuously used in this case. Replace the sensor, however, if highly precise detection is required.

## Warranties and Disclaimers

KEYENCE, at its sole option, will refund, repair or replace at no charge any defective Products within 1 year from the date of shipment. Unless stated otherwise herein, the Products should not be used internally in humans, for human transportation, as safety devices or fail-safe systems. EXCEPT FOR THE FOREGOING, ALL EXPRESS, IMPLIED AND STATUTORY WARRANTIES, INCLUDING WARRANTIES OF MERCHANTABILITY, FITNESS FOR A PARTICULAR PURPOSE AND NON-INFRINGEMENT OF PROPRIETARY RIGHTS, ARE EXPRESSLY DISCLAIMED. KEYENCE SHALL NOT BE LIABLE FOR ANY DIRECT, INDIRECT, INCIDENTAL, CONSEQUENTIAL OR OTHER DAMAGES, EVEN IF DAMAGES RESULT FROM THE USE OF THE PRODUCTS IN ACCORDANCE WITH ANY SUGGESTIONS OR INFORMATION PROVIDED BY KEYENCE. In some jurisdictions, some of the foregoing warranty disclaimers or damage limitations may not apply.

# KEYENCE

## KEYENCE CORPORATION

1-3-14, Higashi-Nakajima, Higashi-Yodogawa-ku,  
Osaka, 533-8555, Japan

Phone: 81-6-6379-2211 Fax: 81-6-6379-2131

### AFFILIATED COMPANIES

#### KEYENCE CORPORATION OF AMERICA

Phone: 201-930-0100 Fax: 201-930-0099

#### KEYENCE DEUTSCHLAND GmbH

Phone: 06102-36 89-0 Fax: 06102-36 89-100

#### KEYENCE (UK) LIMITED

Phone: 01908-696900 Fax: 01908-696777

#### KEYENCE FRANCE S.A.

Phone: 01 56 37 78 00 Fax: 01 56 37 78 01

#### KEYENCE ITALIA S.p.A.

Phone: 02-6688220 Fax: 02-66825099

#### KEYENCE SINGAPORE PTE LTD.

Phone: 6392-1011 Fax: 6392-5055

#### KEYENCE (MALAYSIA) SDN BHD

Phone: 03-2092-2211 Fax: 03-2092-2131

#### KEYENCE (THAILAND) CO., LTD.

Phone: 02-369-2777 Fax: 02-369-2775

#### KEYENCE TAIWAN CO., LTD.

Phone: 02-2718-8700 Fax: 02-2718-8711

#### KEYENCE (HONG KONG) CO., LTD.

Phone: 3104-1010 Fax: 3104-1080

#### KEYENCE INTERNATIONAL TRADING (SHANGHAI) CO., LTD.

Phone: 021-68757500 Fax: 021-68757550

#### KOREA KEYENCE CO., LTD.

Phone: 02-563-1270 Fax: 02-563-1271

Specifications are subject to change without notice.

## Specifications

Type		Main unit	Sub unit (one line)	Analog output (main unit)	Sub unit (zero line)	
Model	Cable	NPN output	FS-V31	FS-V32	FS-V31M	FS-V30
		PNP output	FS-V31P	FS-V32P	-	-
	Connector	NPN output	FS-V31C	FS-V32C	-	-
		PNP output	FS-V31CP	FS-V32CP	-	-
Light source		Red 4-element LED (peak wave length: 640 nm typ.)				
Control output*1	NPN output	NPN open collector 40 V 100 mA max.			-	
	PNP output	PNP open collector 30 V 100 mA max.			-	
	Analog output (FS-V31M only)	1-5 V voltage output: 1-5 V for the display 0-4095 of HSP/FINE/TURBO, load resistance 10 kΩ or more, response time 1 ms				
Control input (connector type only)		Calibration/scaling/zero shift/reset/light emission stop (input time: ON: 2 ms, OFF: 20 ms)			-	
Response time	ON/OFF Output	33 μs (HIGH SPEED)/250 μs (FINE)/500 μs (TURBO)/1 ms (SUPER)/4 ms (ULTRA)/16 ms (MEGA)			193 μs to 16.7 ms	
Number of interference prevention units	Normal time	Power mode	HIGH SPEED	FINE	TURBO/SUPER/ULTRA/MEGA	
		Number of units required to prevent interference	0 units	4 units	8 units	
When double is set *2	When double is set *2	Power mode	HIGH SPEED	FINE	TURBO/SUPER/ULTRA/MEGA	
		Number of units required to prevent interference	0 units	8 units	16 units	
Power voltage		12-24 VDC, Ripple (P-P): 10% max, Class2				
Current consumption	Normal	990 mW (42 mA max. at 24 V, 83 mA max. at 12 V)				
	Power save	820 mW (34 mA max. at 24 V, 68 mA max. at 12 V)				
Operating ambient luminance	Incandescent lamp	20,000 lx max.				
	Sun light	30,000 lx max.				
Operating ambient temperature*1		-10 to +55 °C (No freezing)				
Operating ambient humidity		35 to 85% RH (No condensation)				
Vibration resistance		10 to 55 Hz Compound amplitude 1.5 mm, 2 hours for each of XYZ axes				
Shock resistance		500 m/s <sup>2</sup> 3 times for each of XYZ axes				
Material		Main unit, housing material: Polycarbonate				
Weight (including cable)		Approx. 80g	Approx. 45g	Approx. 80g	Approx. 25g	

\*1 When several units are connected, the operating ambient temperature varies depending on the number of units to be connected. When connecting several units, be sure to mount the units on the DIN rail (mounted on a metal plate), and keep the output current within 20mA.

When 1 to 2 units are connected : -10 to +55 °C,

When 3 to 10 units are connected : -10 to +50 °C,

When 11 to 16 units are connected : -10 to 45 °C

\*2 When double is set, the response time is twice as long as the normal response time.

The accessory of this unit is this instruction manual only.

## Error Displays and Corrective Actions

Error display	Cause	Corrective action
<b>ErC</b>	Overcurrent is flowing in the control output.	Check the load and return the current within the rated value.
<b>ErE</b>	Failed to write/read the internal data.	Perform initialization (p.5).
<b>End APC</b>	The load on the light source is large.	Replace the sensor if high-accuracy detection is required.