

LAYOUT INSPECTION

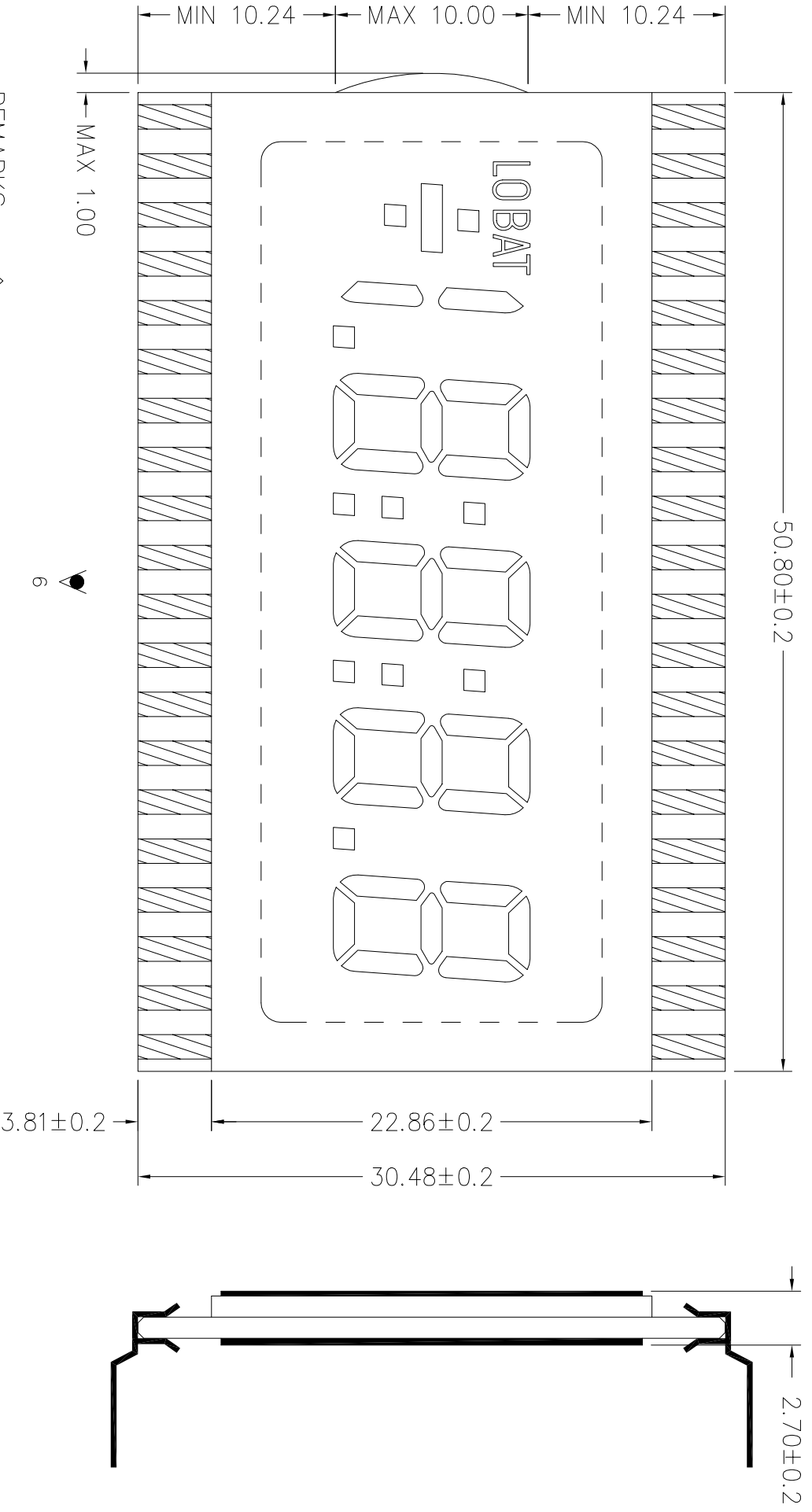

REMARKS:

- ”◇” SPECIAL CHARACTERISTIC
- ”+” SAFETY CHARACTERISTIC
- ”() ” REFERENCE ONLY

VARITRONIX LTD.		Dimension : mm		TOL : ±0.2 IF NOT SPECIFY		DO NOT SCALE DRAWING		3 rd ANGLE PROJECTION	
DRWGNO :	VI-509-DP	REV :	0	Drawn by :	HE	SIGN :		Date :	2005-09-03
		Checked by :	YIN	SIGN :		Date :			

DWG.NO.: VI-509-DP (REV.0)

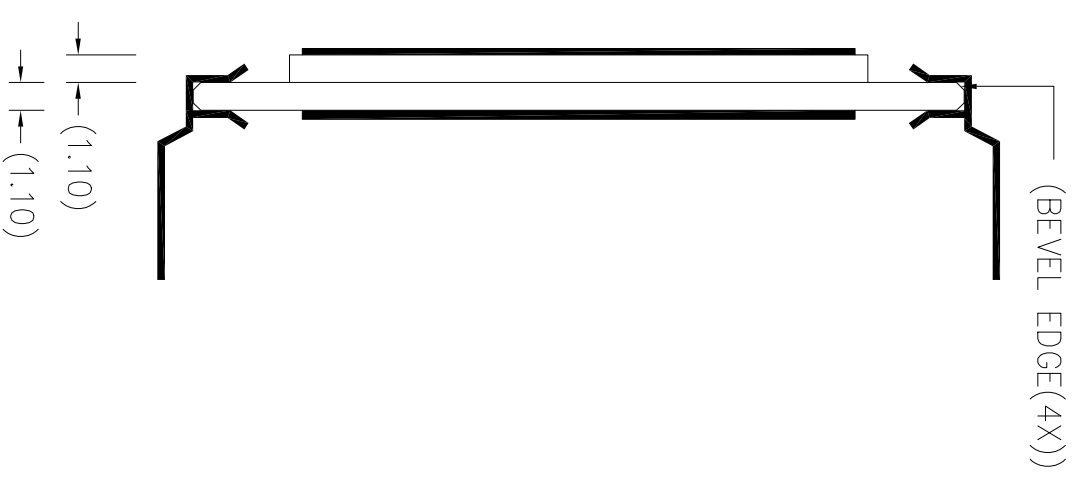
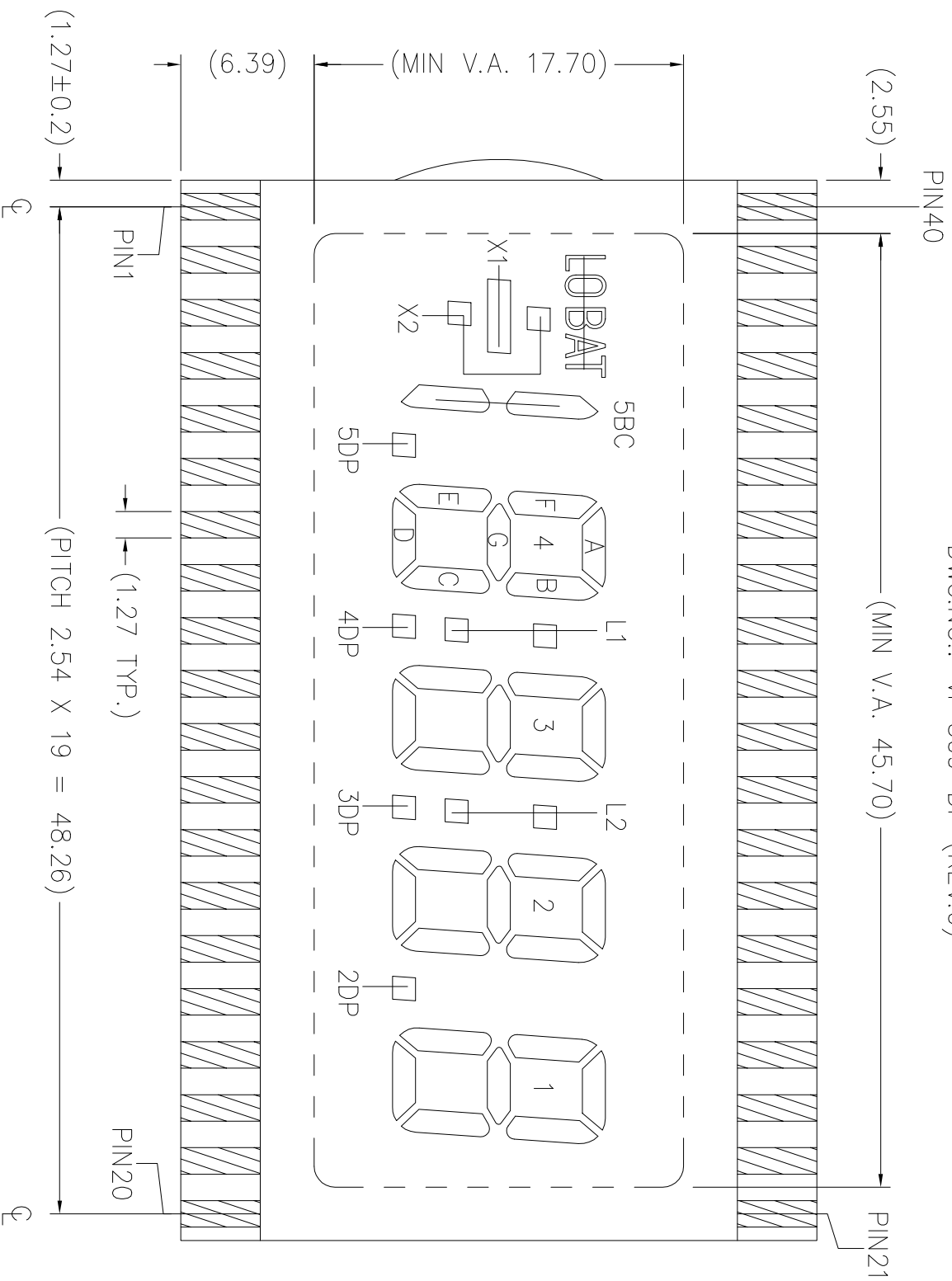

DWG.NO.: VI-509-DP (REV.0)

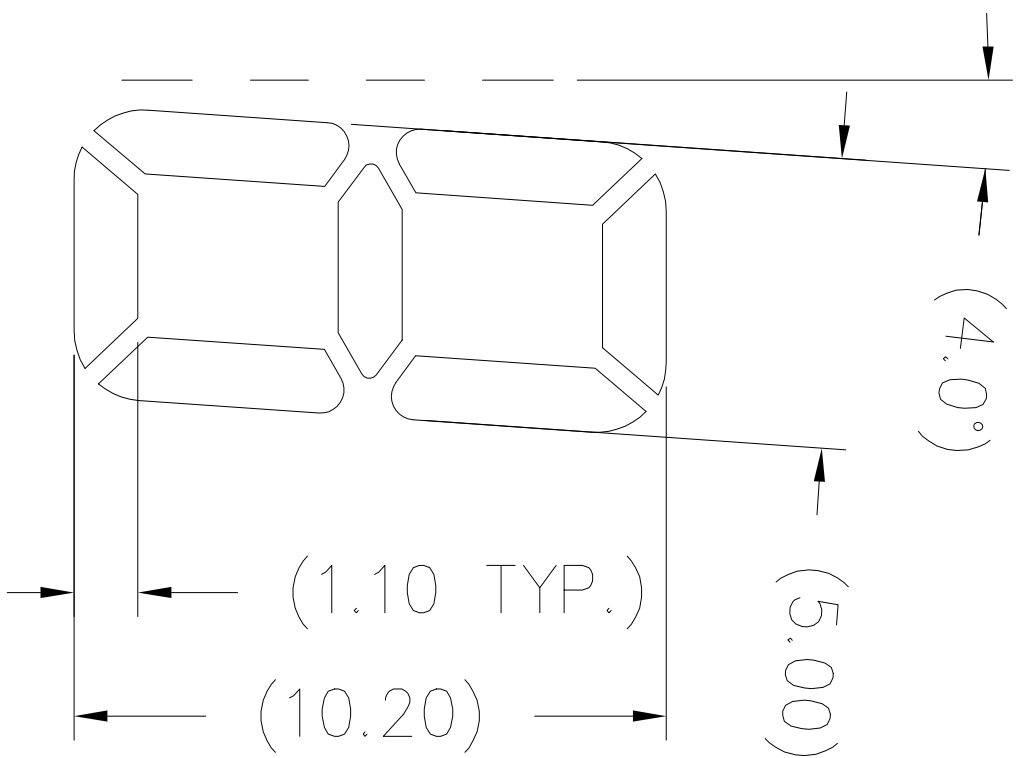

DIGIT 1 - 4

DWG.NO.: VI-509-DP (REV.0)

SEGMENT TRACKING

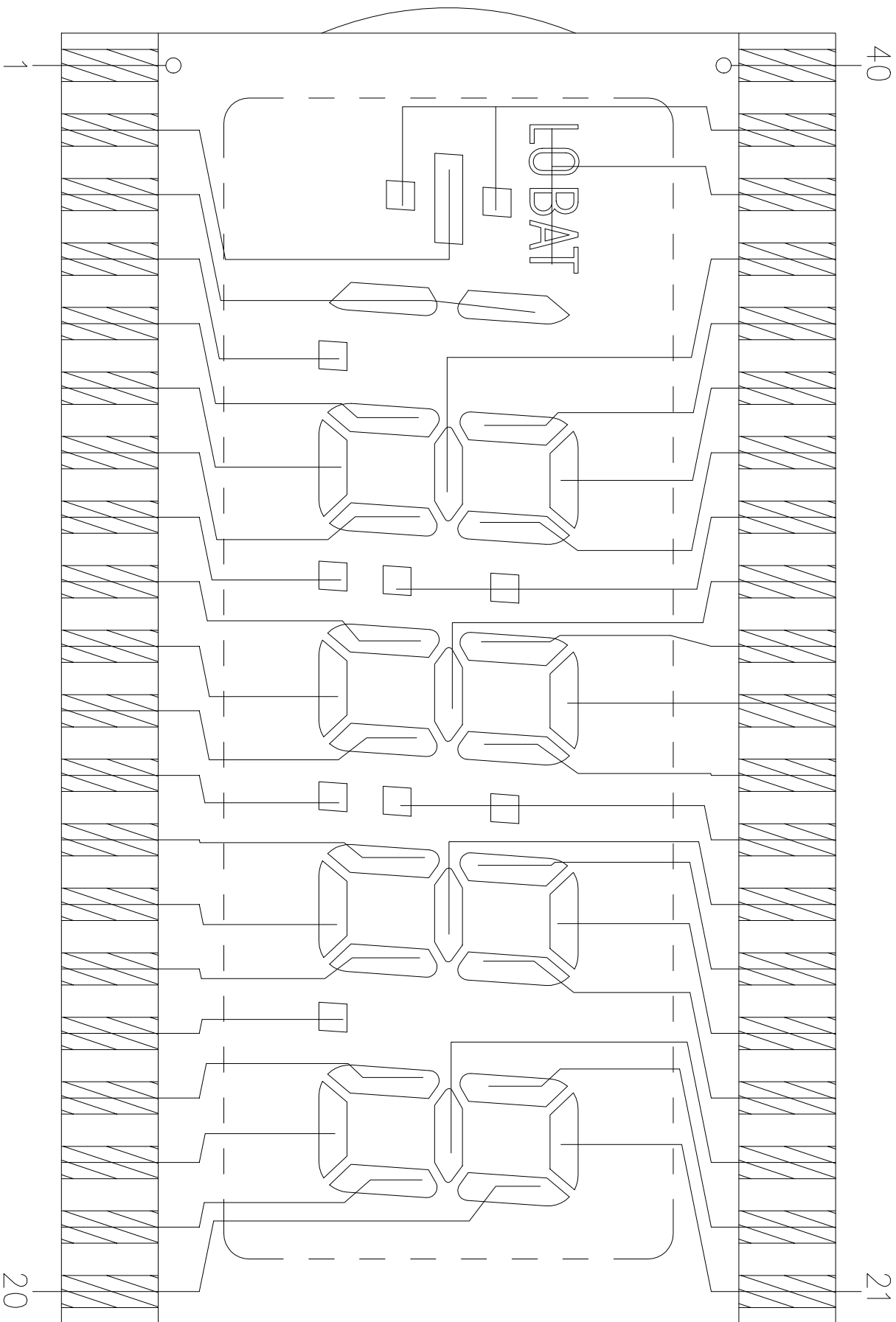

DWG.NO.: VI-509-DP (REV.0)

COMMON TRACKING

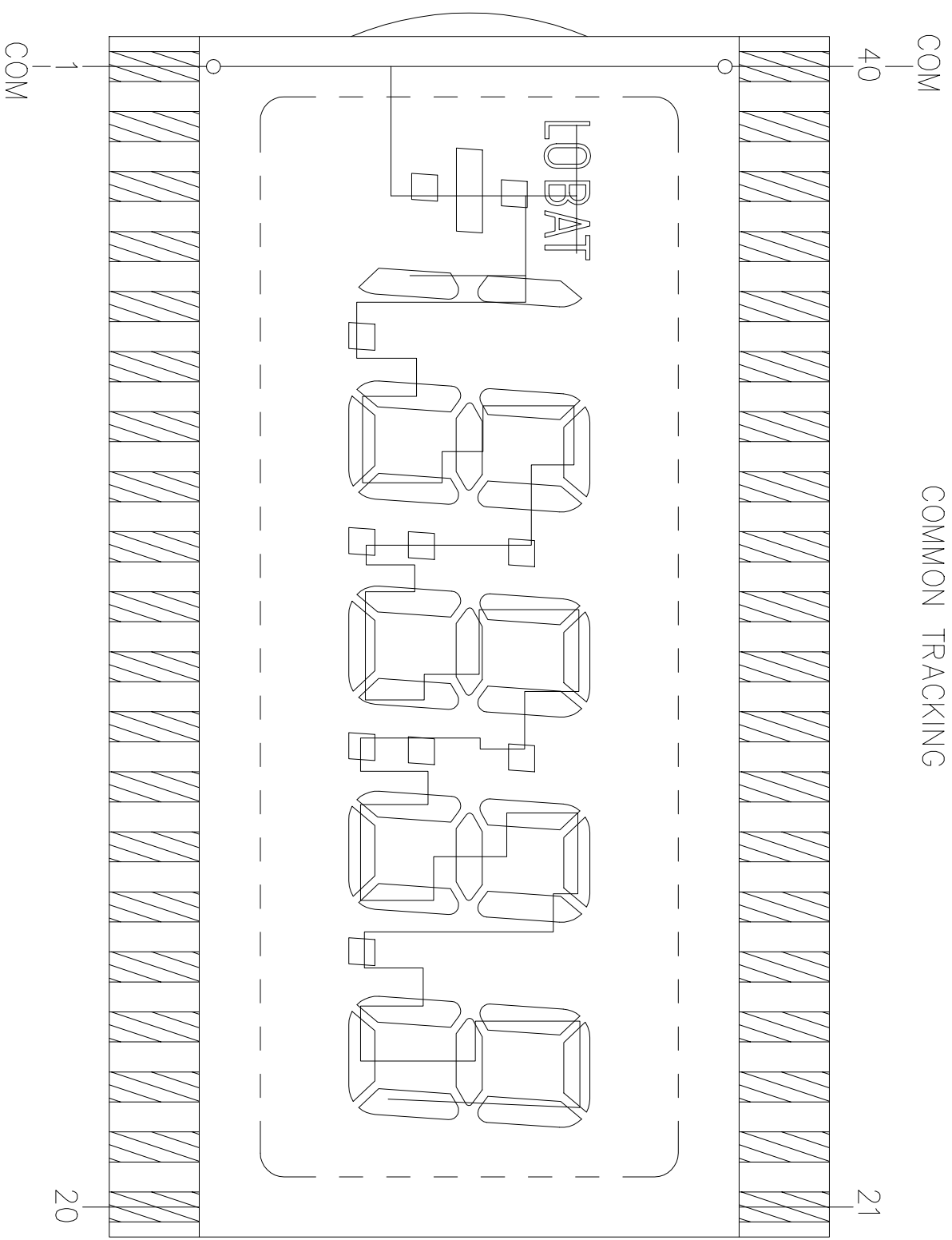

REMARKS : SAME COMMON SHOULD BE CONNECTED TOGETHER ON P.C.B.

DWG.NO.: VI-509-DP (REV.0)

COMMON TRACKING

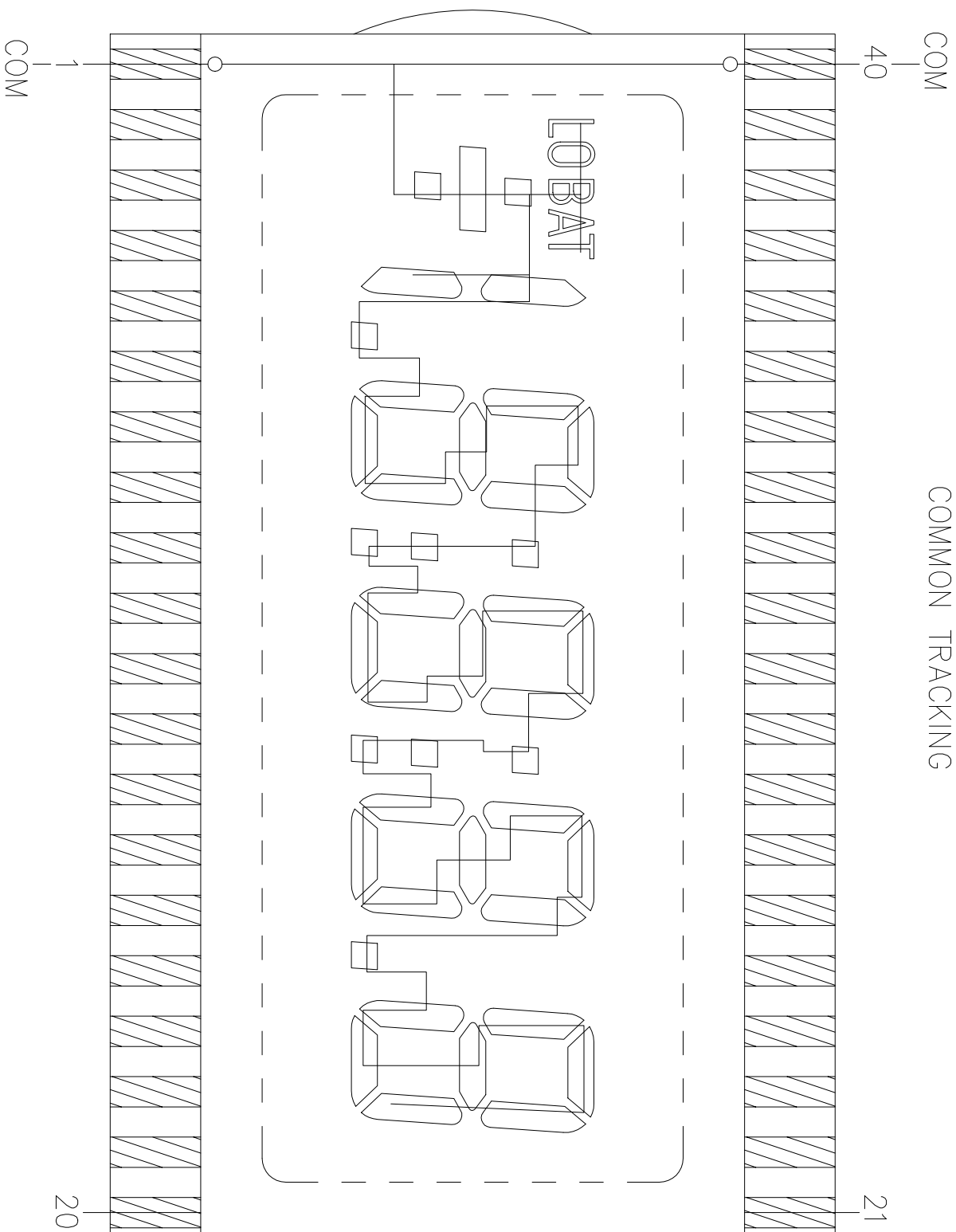

REMARKS : SAME COMMON SHOULD BE CONNECTED TOGETHER ON P.C.B.

DWG.NO.: VI-509-DP (REV.0)

PIN	COM
1	COM
2	X1
3	5BC
4	5DP
5	4E
6	4D
7	4C
8	4DP
9	3E
10	3D
11	3C
12	3DP
13	2E
14	2D
15	2C
16	2DP
17	1E
18	1D
19	1C
20	1B

PIN	COM
21	1A
22	1F
23	1G
24	2B
25	2A
26	2F
27	2G
28	L2
29	3B
30	3A
31	3F
32	3G
33	L1
34	4B
35	4A
36	4F
37	4G
38	LOBAT
39	X2
40	COM

REMARKS: ALL COSMETIC DEFECTS MUST BE ACCEPT OUTSIDE

V.A. EXCEPT ANY CONCERN ON RELIBILITY

SAME COMMON SHOULD BE CONNECTED TOGETHER ON P.C.B.

VARTIRONIX LIMITED		OPEN LAYER :	SCALE
DIL-PIN DETAILS LOCATION DIAGRAM		DP-L0	Do not scale
DOC. NO. : DP-VI-509-DP-01	Drawn by : HE	Date : 2005-09-03	
	Checked by : INA	Date : 2005-09-03	
ALL DIMENSIONS IN mm	Approval by :	Date : 2005-09-06	

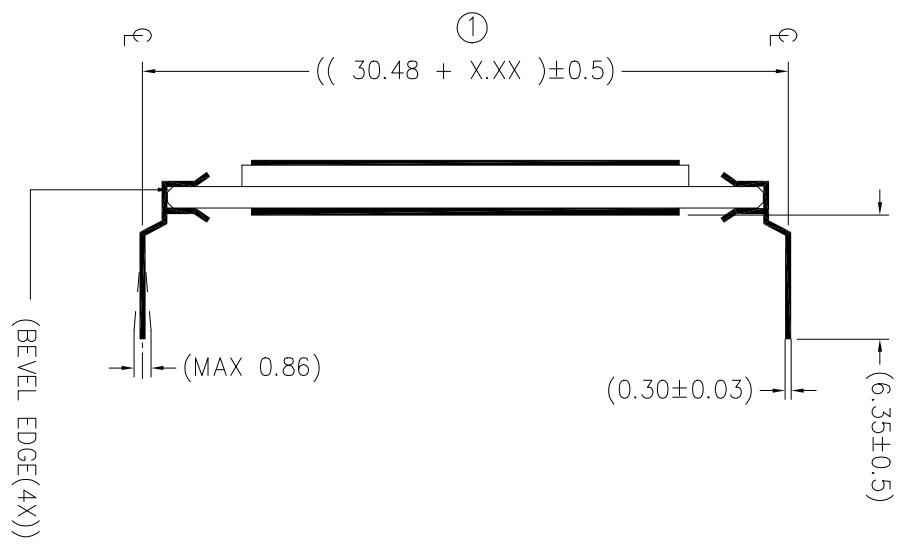
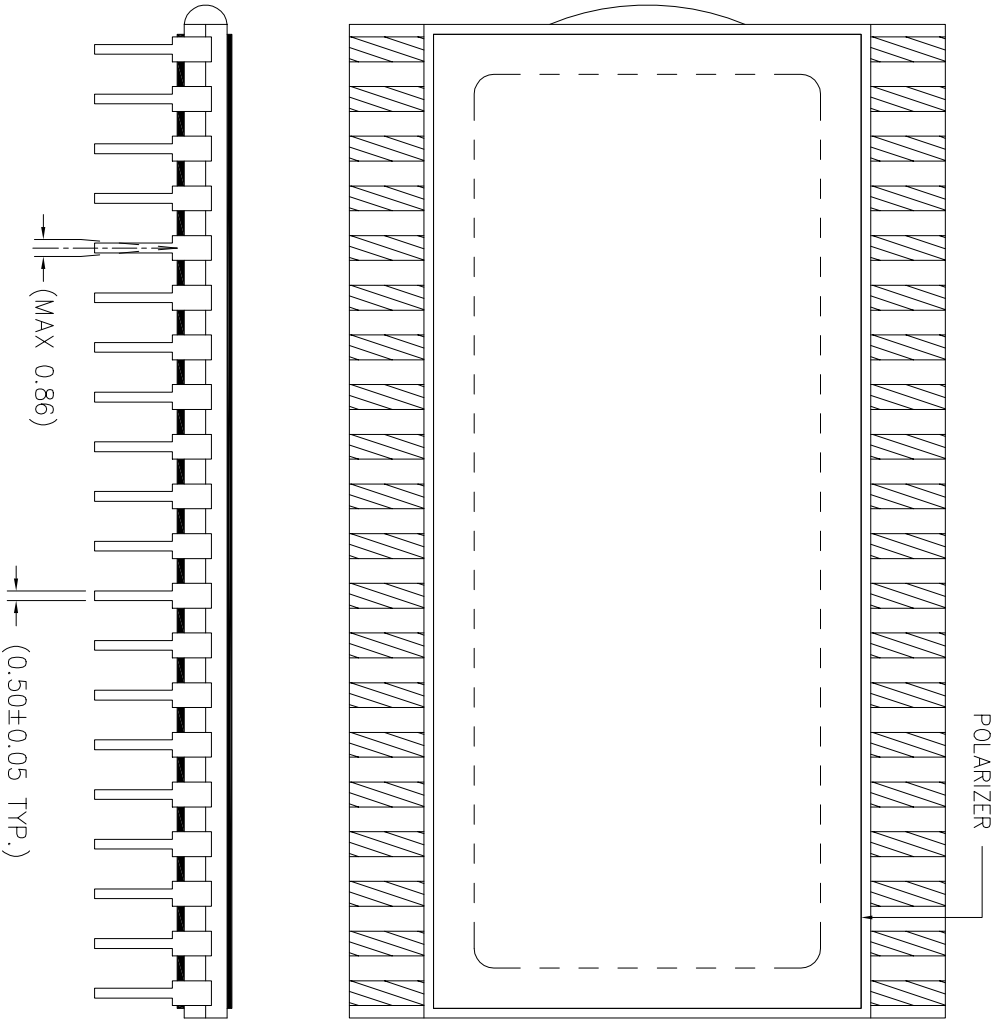

REMARKS: ① ----- X.XX=2.54 (FOR PIN LENGTH ≥ 3.20 & ≤ 10.00 mm)
X.XX=1.75 (FOR PIN LENGTH > 10.00 & ≤ 19.50 mm)

VARTRONIX LIMITED		OPEN LAYER :	SCALE
POLARIZER LOCATION DIAGRAM		P	Do not scale
DOC. NO. : PL-VI-509-DP-01		Drawn by : HE	Date : 2005-09-03
		Checked by : INA	Date : 2005-09-03
		Approval by :	Date : 2005-09-06

